



IBM **Spectrum Scale**

# IBM Spectrum Scale Update

**US User Group Meeting 2017**  
**Berkeley – Apr 4<sup>th</sup>+5<sup>th</sup>, 2017**

**Ulf Troppens**

The world is changing ...



# 2005

The world is changing ...

2005



2013



# GPFS is changing ...

- 1993: Started as “Tiger Shark” research project at IBM Research Almaden as high performance filesystem for accessing and processing multimedia data
- Next 20 years: Grew up as General Parallel File System (GPFS) to power the world’s largest supercomputers
- Since 2014: Transforming to IBM Spectrum Scale to support new workloads which need to process huge amounts of unstructured data

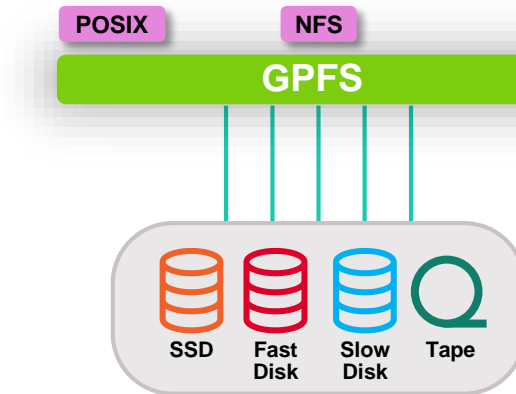

# IBM Spectrum Scale

- Based on GPFS, a robust, fast and mature parallel file system
- BUT: If you still just think GPFS, you miss:
  - Support for workflows which for example inject data via object, analyze results via Hadoop/Spark and view results via POSIX
  - Storing and accessing large and small objects (S3 and Swift) with low latency
  - Automatic destaging of cold data to on premise or off premise object storage
  - Exchange of data between Spectrum Scale clusters via object storage in the cloud
  - Storing and starting OpenStack VMs without copying them from object storage to local file system
  - GUI, Grafana Bridge, REST API
  - iSCSI boot
  - And many, many more



IBM Spectrum Scale

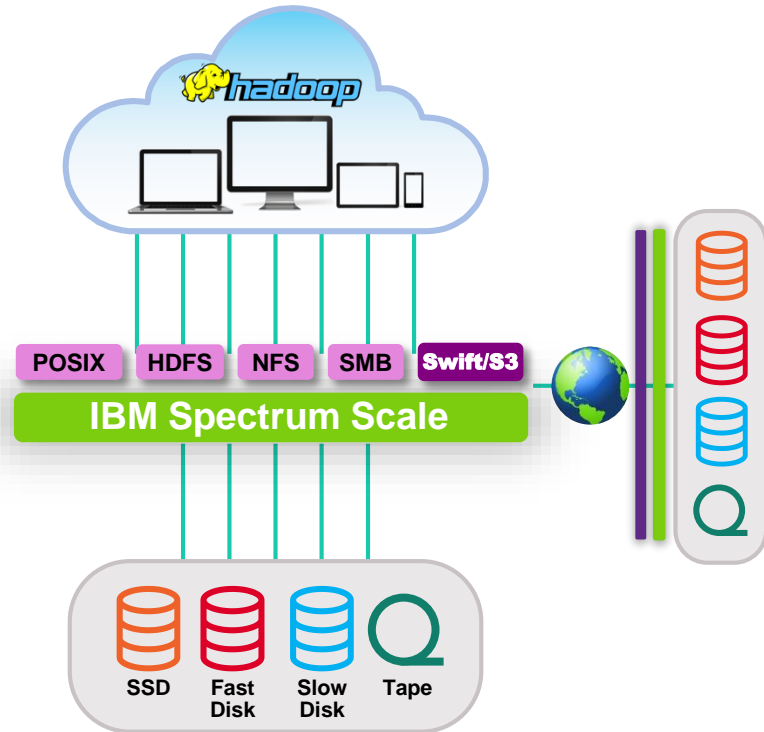

# The History of IBM Spectrum Scale



"One of the 2016 Leader in Gartner MQ for Distributed File Systems and Object Storage"\*

This infographic is the genealogy of IBM Spectrum Scale, from its birth as a digital media server and HPC research project to its place as a foundational element in the IBM Spectrum Storage family. It highlights key milestones in the product history, usage, and industry to convey that Spectrum Scale may have started as GPFS, but it is so much more now. IBM has invested in the enterprise features that make it easy to use, reliable and suitable for mission critical storage of all types.

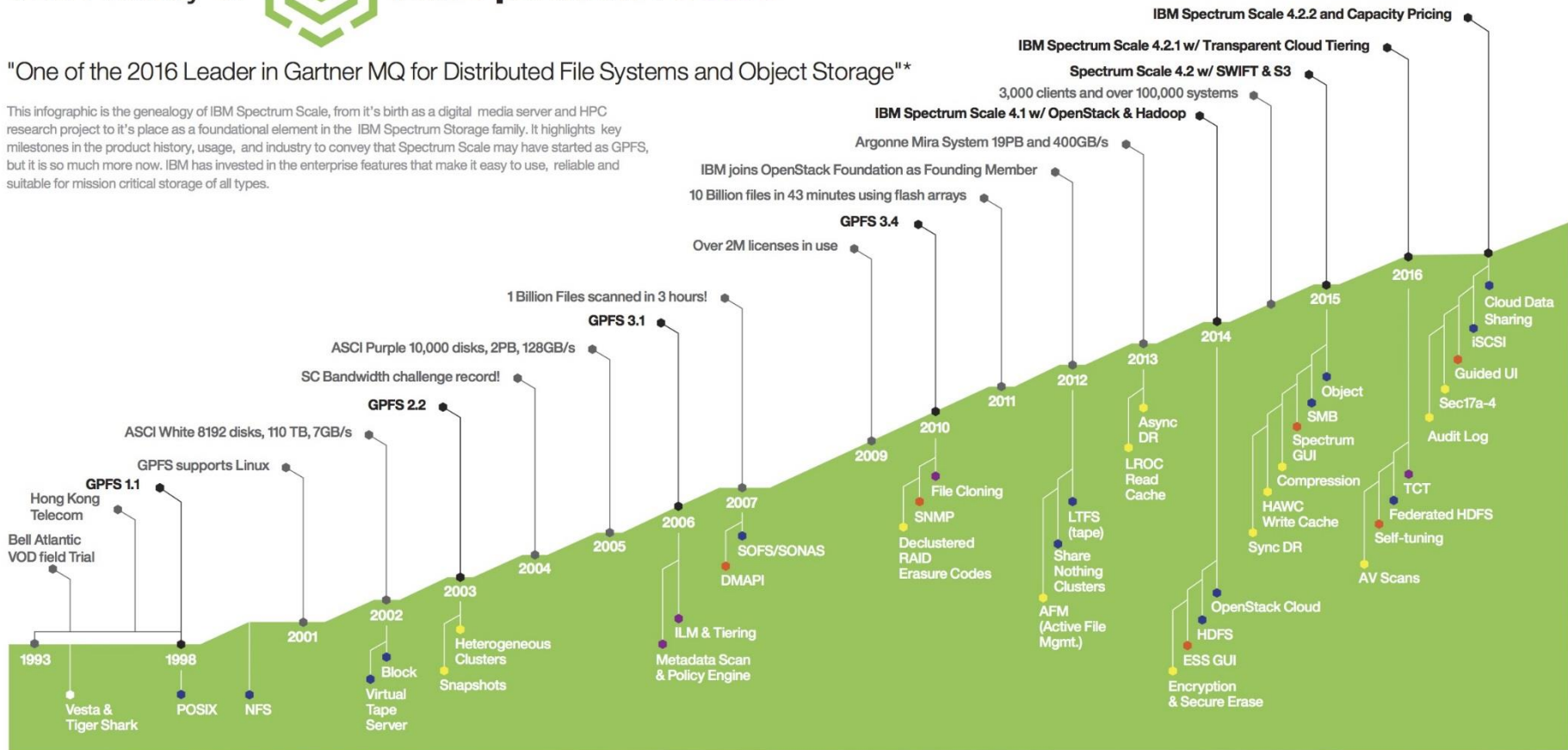

● UNIFIED STORAGE ● STORAGE TIERING ● DATA MANAGEMENT ● USABILITY

\* Gartner, Magic Quadrant for Distributed File Systems and Object Storage, 20 October 2016, Document No. G00307798



# Unleash New Storage Economics on a Global Scale



## Single name space

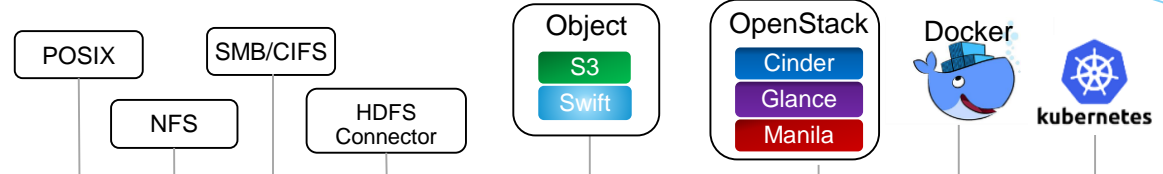

## IBM Spectrum Scale

Automated data placement and data migration

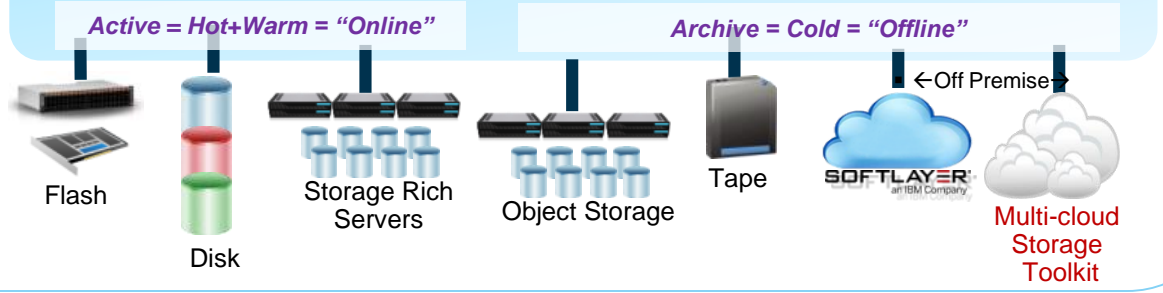

# 1) Understand Use Case

Core  
HPC

File-based  
Workflows

Application  
Acceleration

Virtual  
Infrastructure

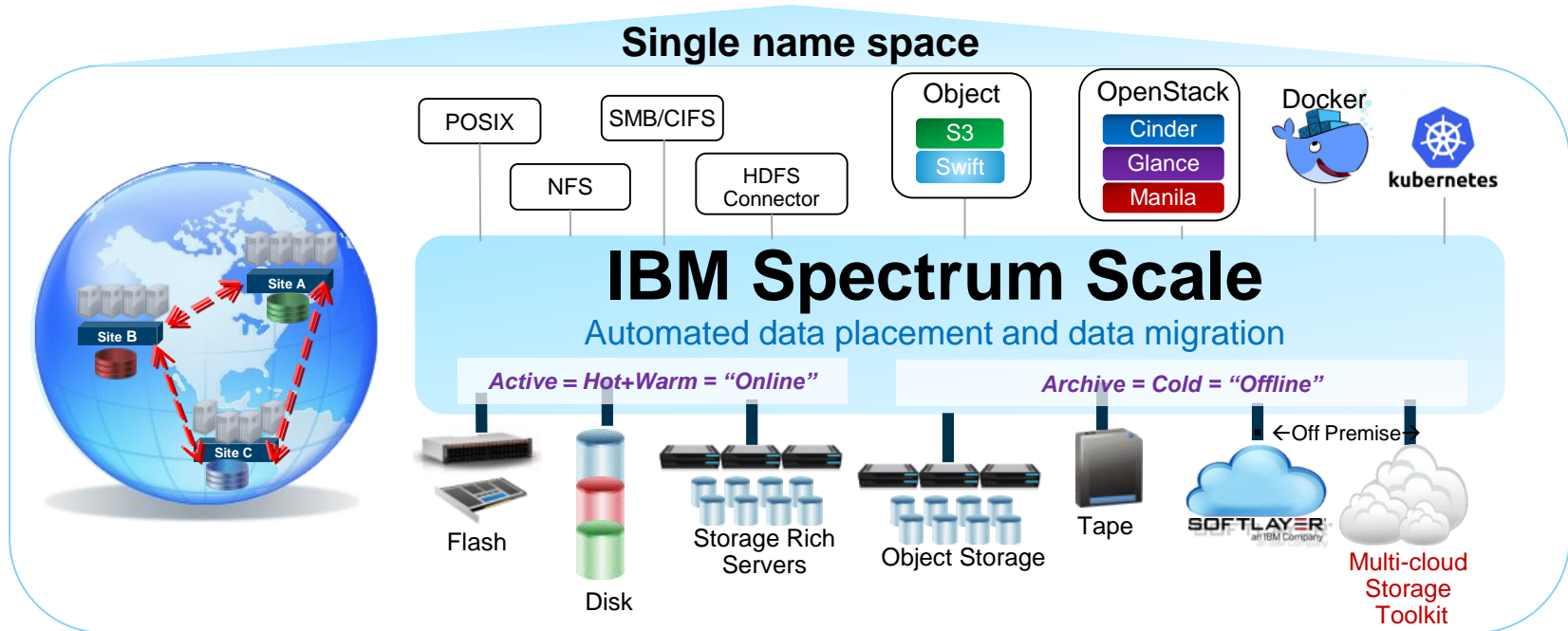



## 2) Define the Spectrum Scale Configuration

Core  
HPC

File-based  
Workflows

Application  
Acceleration

Virtual  
Infrastructure

# IBM Spectrum Scale

File Services / File Storage Virtualization / Application Integration  
Software-defined Storage Freedom

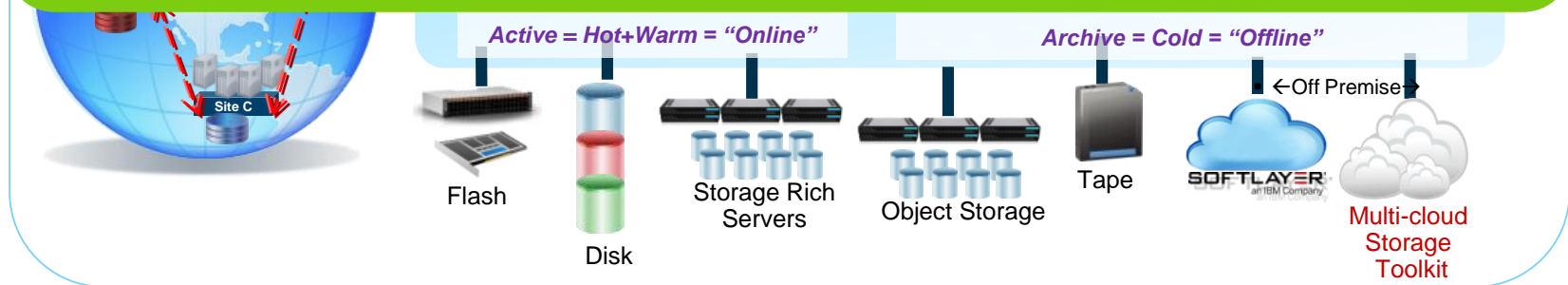

### 3) Select Best of Breed Storage

**Core  
HPC**

**File-based  
Workflows**

**Application  
Acceleration**

**Virtual  
Infrastructure**

## **IBM Spectrum Scale**

**File Services / File Storage Virtualization / Application Integration  
Software-defined Storage Freedom**

## **Freedom of Choice**

**Choose Storage which Meets your Needs  
Flash // Disk // Tape // Object // Cloud**

## 4) Network is Integral Part of End-to-end Solution

**Core  
HPC**

**File-based  
Workflows**

**Application  
Acceleration**

**Virtual  
Infrastructure**

### **IBM Spectrum Scale**

**File Services / File Storage Virtualization / Application Integration**

**Network**

**Software-defined Storage Freedom**

### **Freedom of Choice**

**Choose Storage which Meets your Needs  
Flash // Disk // Tape // Object // Cloud**

## Examples – Core HPC

**Core  
HPC**

**File-based  
Workflows**

**Application  
Acceleration**

**Virtual  
Infrastructure**

# IBM Spectrum Scale

**File Services / File Storage Virtualization / Application Integration**

**Network**

**Software-defined Storage Freedom**

## Freedom of Choice

**Choose Storage which Meets your Needs  
Flash // Disk // Tape // Object // Cloud**

# What is CORAL

## Collaboration of DOE Oak Ridge, Argonne, and Lawrence Livermore National Labs

- Established in early 2014 to leverage supercomputing investments, streamline procurement processes and reduce costs to develop supercomputers
  - “High-performance computing is an essential component of the science and technology portfolio required to maintain U.S. competitiveness and ensure our economic and national security”  
- U.S. Secretary of Energy Ernest Moniz
- Two new High Performance Computing (HPC) awards announced in November 2014
  - Both CORAL awards leverage the IBM Power Architecture, NVIDIA’s Volta GPU and Mellanox’s Interconnected technologies to advance key research initiatives for national nuclear deterrence, technology advancement and scientific discovery
  - Oak Ridge National Laboratory’s (ORNL’s) new system, Summit, is expected to provide at least five times the performance of ORNL’s current leadership system, Titan
  - Lawrence Livermore National Laboratory’s (LLNL’s) new supercomputer, Sierra, is expected to be at least seven times more powerful than LLNL’s current machine, Sequoia.

Source: <http://energy.gov/articles/department-energy-awards-425-million-next-generation-supercomputing-technologies>

# CORAL Systems

- **LLNL's Sierra system**

- ~4000 Power9 nodes with GPU acceleration
- ~2.3 PB system memory (include DDR & HBM; does not include NVMe)
- Dual-rail InfiniBand EDR fat tree network or better
- ~120 PF
- ~9 MW

- **ORNL's Summit system**

- ~4500 Power9 nodes with GPU acceleration
- ~ 2.7 PB system memory (include DDR & HBM; does not include NVMe)
- Dual-rail InfiniBand EDR fat tree network or better
- ~200 PF peak
- ~13 MW

# CORAL System Storage Overview

## Storage architecture

- Need for a burst buffer/performance tier
  - Lowers traditional spinning disk & lower power consumption
  - Node local NVMe SSD managed by Burst Buffer Software
- Capacity requirement – ESS Storage
- Performance/Scaling requirements – Spectrum Scale Software

# CORAL Storage Overview

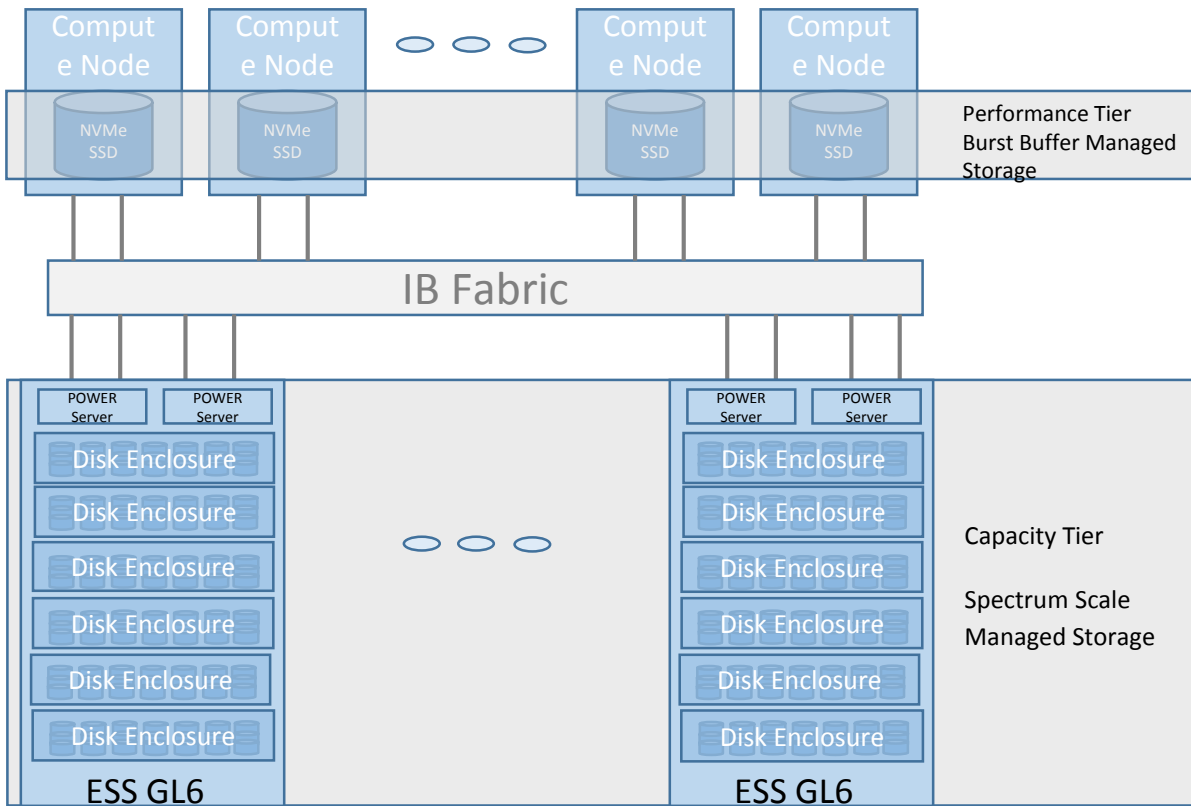

[http://files.gpfsug.org/presentations/2016/SC16/11\\_Sarp\\_Oral\\_Gautam\\_Shah\\_Spectrum\\_Scale\\_Enhancements\\_for\\_CORAL\\_v2.pdf](http://files.gpfsug.org/presentations/2016/SC16/11_Sarp_Oral_Gautam_Shah_Spectrum_Scale_Enhancements_for_CORAL_v2.pdf)



## Spider 3 @ OLCF

Spider 3 is a center-wide single namespace POSIX file system to serve all OLCF resources eliminating data islands, and enabling seamless data sharing between resources

- Built on IBM's Elastic Storage Server based on Power 9 Processor and uses Spectrum Scale (formerly known as GPFS) parallel filesystem technology utilizing GPFS Native RAID with 8+2 redundancy
- Provides a usable capacity of 250 PB
- Performs at an aggregate sequential peak read/write bandwidth of 2.5 TB/s
- Performs at an aggregate random peak read/write bandwidth of 2.2 TB/s
- Provides rich metadata performance; single directory parallel create rate of 50,000/s
- Provides rich interactive performance; @32 KiB I/O 2.6 million IOPs
- Disk-based, with tens of thousands of disks
- Connected to OLCF's SION 3 SAN with IB EDR
- Will also serve as the Summit Burst Buffer sink and source on the end-to-end I/O path

➔ See here for supporting Spectrum Scale Enhancements:

[http://files.gpfsug.org/presentations/2016/SC16/11\\_Sarp\\_Oral\\_Gautam\\_Shah\\_Spectrum\\_Scale\\_Enhancements\\_for\\_CORAL\\_v2.pdf](http://files.gpfsug.org/presentations/2016/SC16/11_Sarp_Oral_Gautam_Shah_Spectrum_Scale_Enhancements_for_CORAL_v2.pdf)

## Examples – File-based Workflows

**Core  
HPC**

**File-based  
Workflows**

**Application  
Acceleration**

**Virtual  
Infrastructure**

### **IBM Spectrum Scale**

**File Services / File Storage Virtualization / Application Integration**

**Network**

**Software-defined Storage Freedom**

### **Freedom of Choice**

**Choose Storage which Meets your Needs  
Flash // Disk // Tape // Object // Cloud**

# Changes in Science

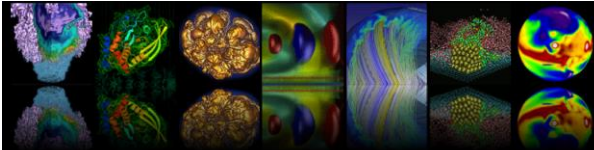
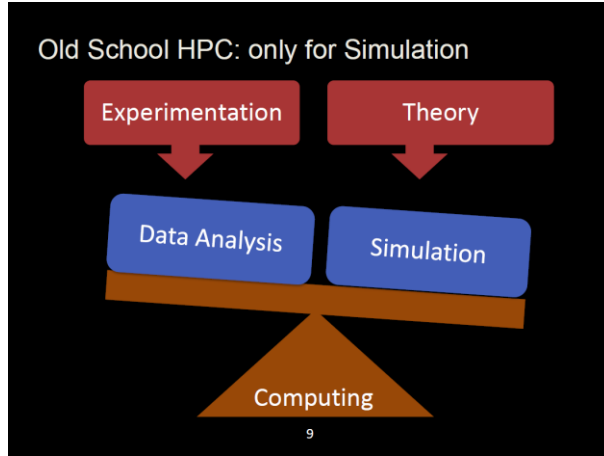

## Extreme Data Science

The scientific process is poised to undergo a radical transformation based on the ability to access, analyze, simulate and combine large and complex data sets.

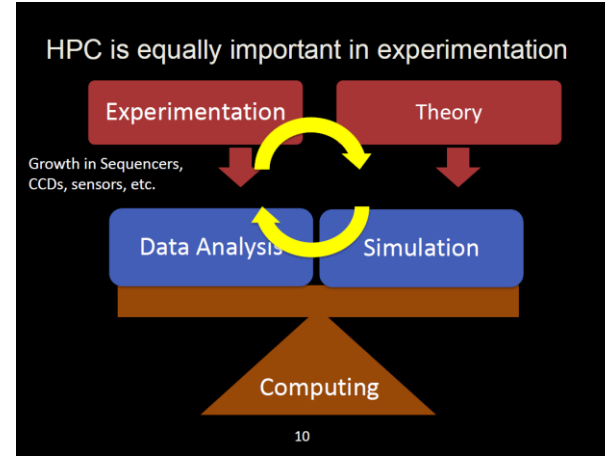

- Data driven science is getting the norm
- HPC gets integrated into the experiments to analyze huge amounts of measured data
- This shift is seen in scientific research and in industry (e.g. life-science, automotive)

[https://science.energy.gov/~media/ascr/ascac/pdf/meetings/201609/Yelick\\_Superfacility-ASCAC\\_2016.pdf](https://science.energy.gov/~media/ascr/ascac/pdf/meetings/201609/Yelick_Superfacility-ASCAC_2016.pdf)

# Typical Workflow for Data Intensive Science

- a) Real-time data ingest (data acquisition)
- b) Visualization and near real-time analysis (online processing)
- c) Data movement from Burst Buffer to Central Storage
- d) Deep analysis (offline processing)
- e) Data management of Central Storage
- f) Long-term data archiving

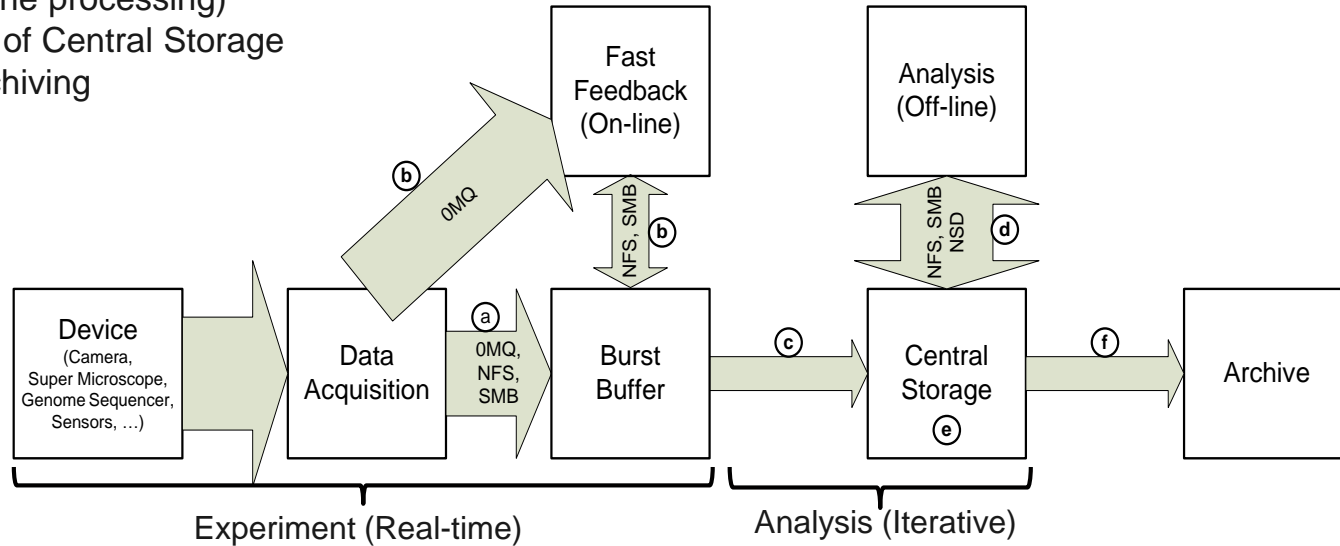

- Scientists need access to data during each stage of the workflow

# Typical Workflow for Data Intensive Science (continued)

- a) Real-time data ingest (data acquisition)
- b) Visualization and near real-time analysis (online processing)
- c) Data movement from Burst Buffer to Central Storage
- d) Deep analysis (offline processing)
- e) Data management of Central Storage
- f) Long-term data archiving

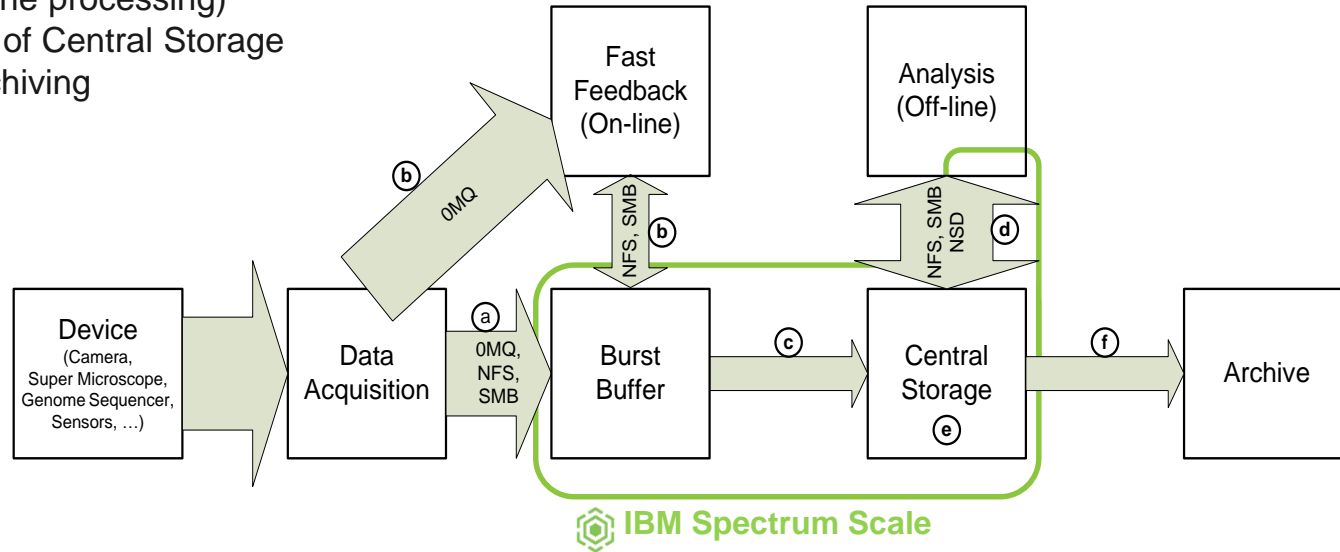

- Scientists need access to data during each stage of the workflow
- IBM Spectrum Scale has proven to support this workflow

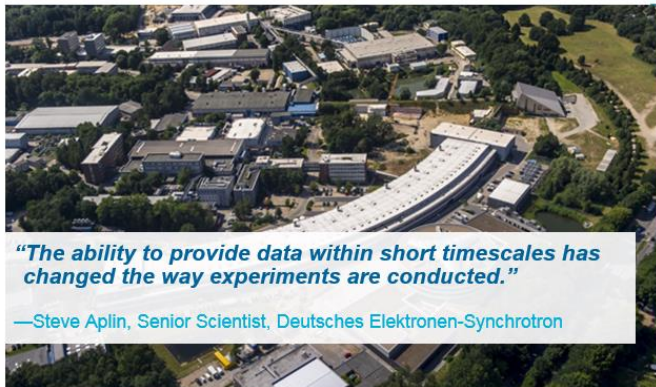

*"The ability to provide data within short timescales has changed the way experiments are conducted."*

—Steve Aplin, Senior Scientist, Deutsches Elektronen-Synchrotron

### Business challenge

Research center Deutsches Elektronen-Synchrotron (DESY) found that increasingly resource-intensive experiments was affecting storage system performance, limiting research. How could the organization handle over five gigabytes of data streaming into its computing center every second?

### Transformation

With a flexible, high-performance storage solution from IBM, DESY can meet growing demand cost-effectively. Scientists can now start analyzing the data in just a few minutes, instead of days, accelerating ground-breaking research.

### Business benefits:

#### Ensures

DESY can easily maintain a multi-PB library of research data to meet growing demand and remain an attractive research destination

#### Rapid

access to millions of data points accelerates research and helps lead to breakthroughs

#### Increases

administration efficiency with automated data management, improving DESY's service offering

## DESY

# Making the next breakthrough in scientific research possible with the latest in storage innovation

DESY, Deutsches Elektronen-Synchrotron, is a national research center in Germany that operates particle accelerators and photon science facilities used to investigate the structure of matter. DESY is housed in Hamburg and Zeuthen, Germany, and attracts over 3,000 scientists from over 40 countries annually.

### Solution components

- IBM® Spectrum Scale™
- IBM Spectrum Scale RAID
- IBM Elastic Storage™ Server GS1
- IBM Elastic Storage Server GL4 and GL6
- IBM Power® S822L
- IBM Systems Lab Services

### Share this



# Current and Future Detector Rates

## > Detectors exceeded capabilities of prev. system:

- Pilatus 300k: 1,2 MB Files @ 200 Hz
- Pilatus 6M: 25 MB files @ 25 Hz  
7 MB files @ 100 Hz
- PCO Edge: 8 MB files @ 100Hz
- PerkinElmer: 16 MB + 700 Byte files @ 15 Hz
- Lambda: 60 Gb/s @ 2000 Hz (Future)
- Eiger: 30 Gb/s @ 2000 Hz (Future)



## > GPFS is now used to handle those rates

- SMB/NFS sufficient for current detectors
- Future detectors need new methods

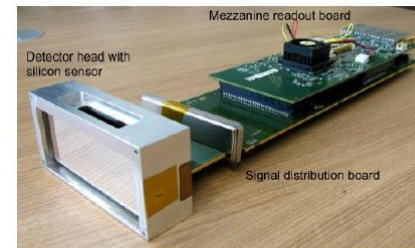

# from the cradle to the grave

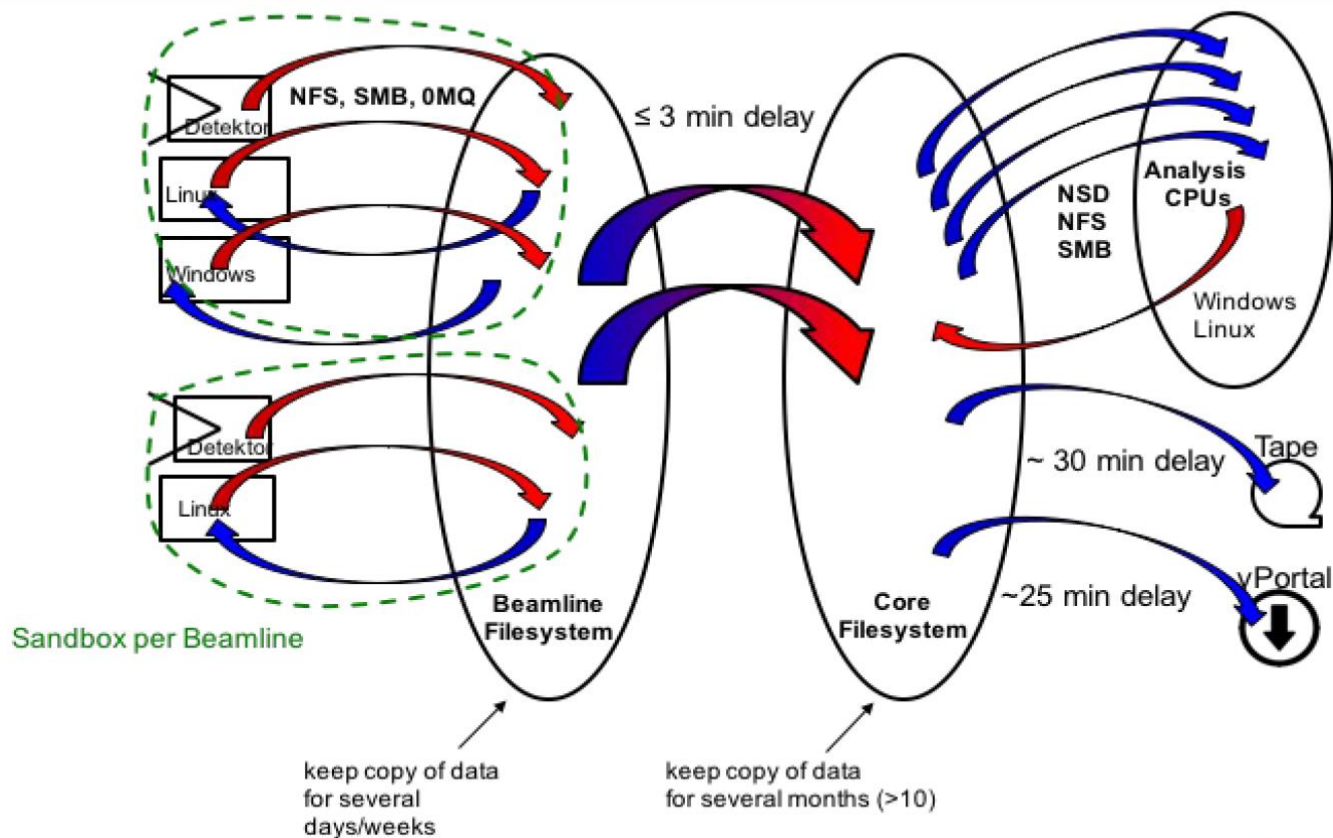



# ASAP<sup>3</sup> Architecture

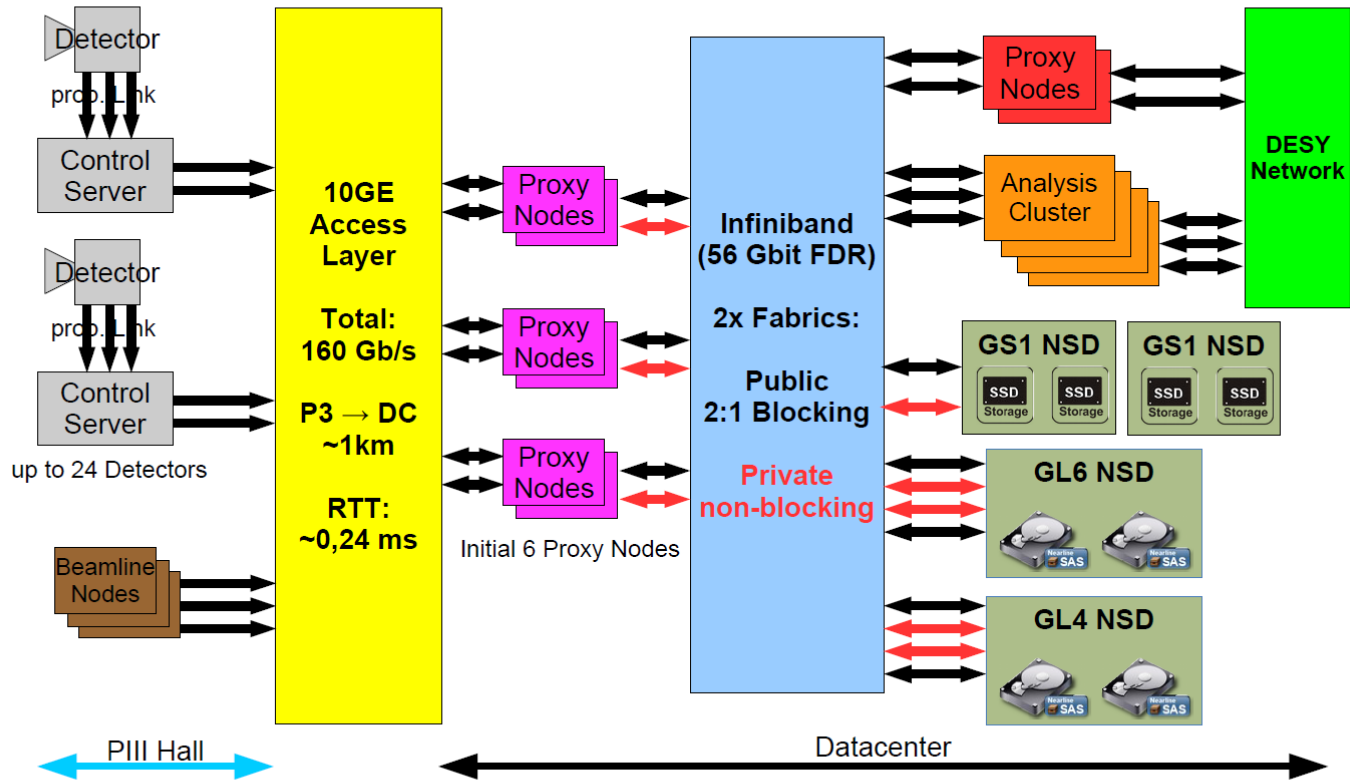

# Resources

- Detailed whitepaper published by DESY at CHEP2015  
<http://iopscience.iop.org/article/10.1088/1742-6596/664/4/042053>
- DESY presentation at IBM Edge 2015:  
<http://www.slideshare.net/UlfTroppens/desy-ibm-edge2015-technical-computing-for-photon-science-20150520v2>
- DESY presentation at ALICE, ATLAS, CMS & LHCb Second Joint Workshop on DAQ@LHC:  
<https://indico.cern.ch/event/471309/contributions/1981091/attachments/1257042/1856128/gpfs-for-p3xfel.pdf>
- IBM customer story with video and four page pdf:  
<http://ibm.co/1qCIAuL>



# Future of Data Analytics

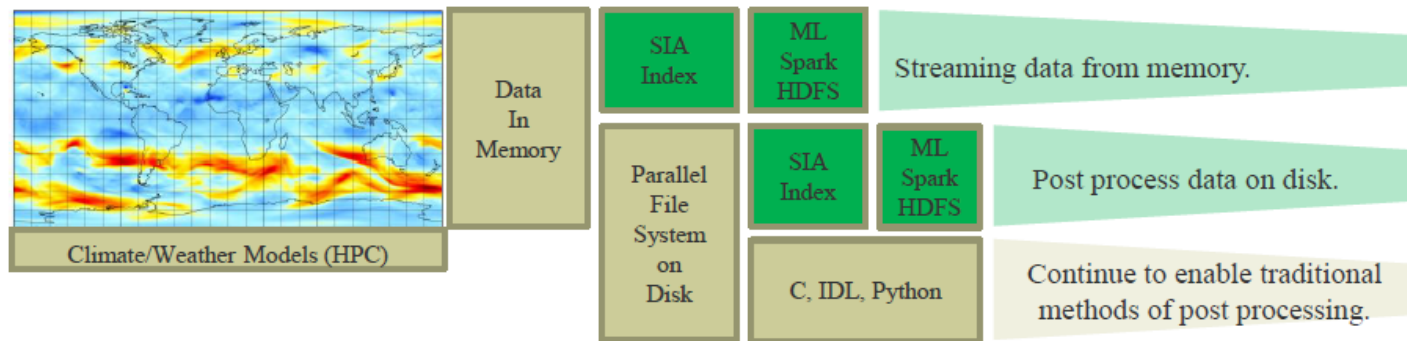

- Future HPC systems must be able to efficiently transform information into knowledge using both traditional analytics and emerging *machine learning* techniques.
- Requires the ability to be able to index data in memory and/or on disk and enable analytics to be performed on the data where it resides – even in memory
- All without having to modify the data

# New Spectrum Scale HDFS Transparency Design

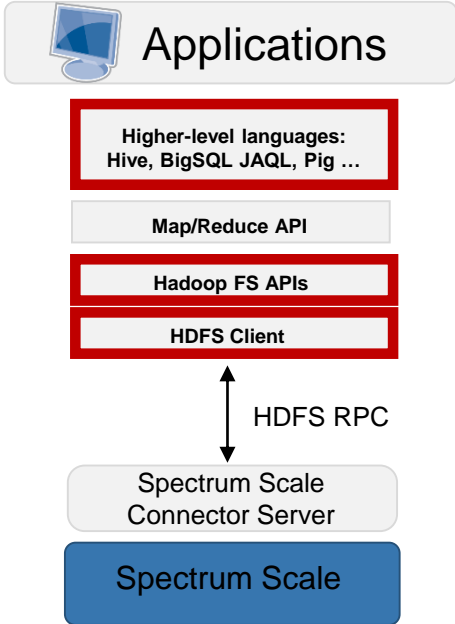

hdfs://hostnameX:portnumber

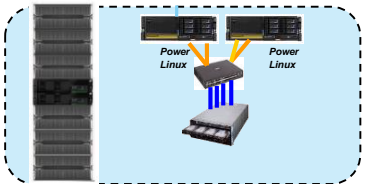
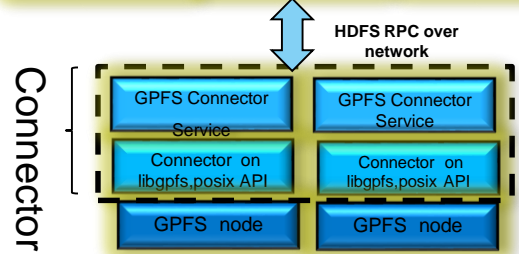
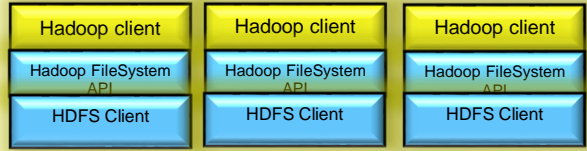

Supported Hadoop versions: 2.7.1



# IBM Delivers New Platform to Help Clients Address Storage Challenges at Massive Scale

**Las Vegas, NV (IBM PartnerWorld) – 14 Feb 2017:** IBM (NYSE: [IBM](#)) and Hortonworks (NASDAQ: HDP) today announced the planned availability of Hortonworks Data Platform (HDP®) for IBM Elastic Storage Server (ESS) and IBM Spectrum Scale. The agreement with Hortonworks will lead to certification of Hortonworks HDP on Power with IBM Spectrum Scale and Hortonworks HDP on x86 with IBM Spectrum Scale.

<https://hortonworks.com/press-releases/ibm-delivers-new-platform-help-clients-address-storage-challenges-massive-scale/>

# Store everywhere. Run anywhere.

## *Content Repositories*

### Challenge

Object storage for static data

- Seamless scaling
- RESTful data access
- Object metadata replaces hierarchy
- Storage efficiency

### Spectrum Scale Swift & S3

- High-performance for object
- Native OpenStack Swift support w/ S3
- File or object in; Object or file out
- Enterprise data protection
- Spectrum Scale RAID (ESS)
- Transparent ILM
- Encryption of data at rest and Secure Erase



# Store everywhere. Run anywhere.

*Analytics without complexity*

## Challenge

Separate storage systems for ingest, analysis, results

- HDFS requires locality aware storage (namenode)
- Data transfer slows time to results
- Different frameworks & analytics tools use data differently

## HDFS Transparency

- Map/Reduce on shared, or shared nothing storage
- No waiting for data transfer between storage systems
- Immediately share results
- Single 'Data Lake' for all applications
- Enterprise data management
- Archive and Analysis in-place

→ Analyze object and file data without copying into HDFS

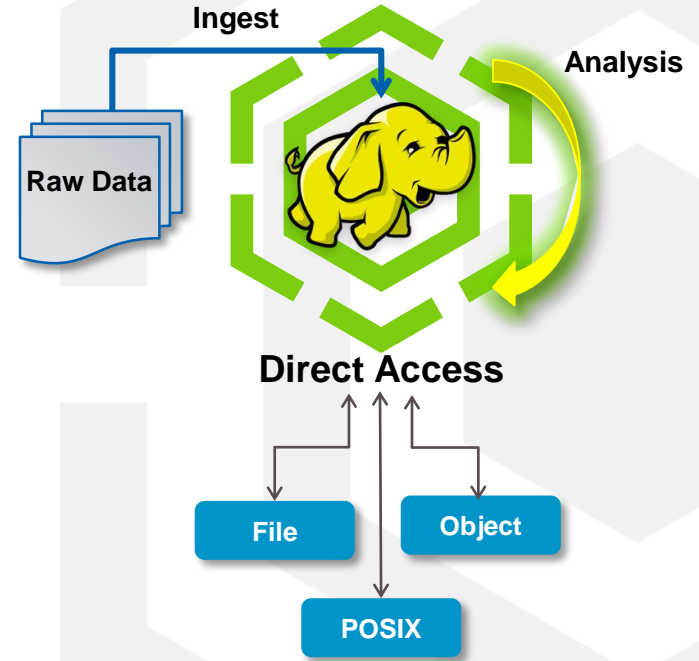

# Backup Of Large Spectrum Scale File Systems

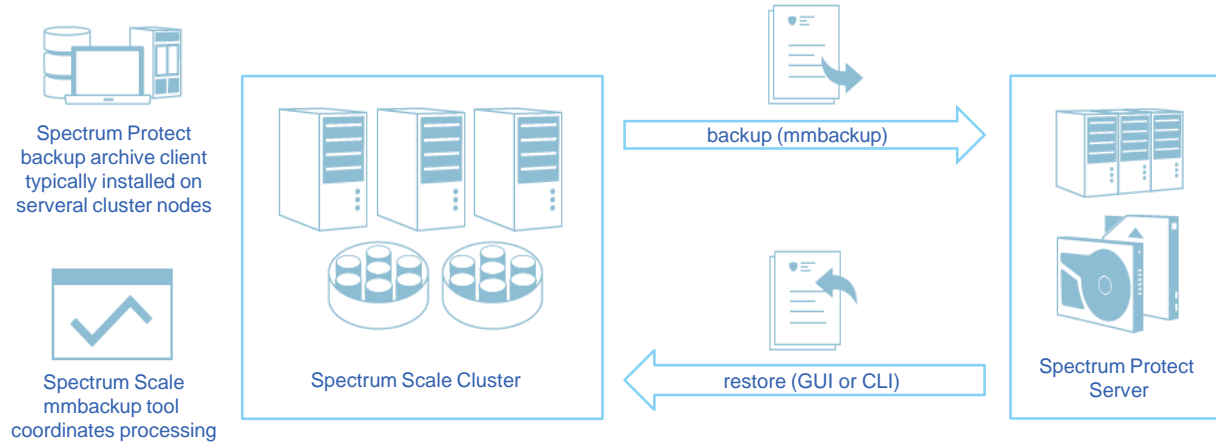

## Function

- Massive parallel filesystem backup processing
- Spectrum Scale mmbbackup creates local shadow of Spectrum Protect DB and uses policy engine to identify files for backup
- Spectrum Protect backup archive client is used under the hood to backup files to Spectrum Protect Server
- Spectrum Protect restore (CLI or GUI) can be used to restore files

- ➔ Use any backup program to backup file, object and Hadoop data
- ➔ Use Spectrum Protect to benefit from mmbbackup and SOBAR to backup and restore huge amounts of data



# Distributed workflows – University Queensland

## Problem statement

- “At the moment if you store some data at this remote data centre in the cloud storage, and then you want to manipulate that on campus, you have to manually copy it, and then work on it locally and then send it back, or delete it, or whatever else, to manage it.”
- “The problem has been that until now, QRIScloud and the on-campus data centres have operated as separate storage silos”
- “This has made the process of storing and moving data from one location to another a less-than-user-friendly process for already busy researchers”

## Customer Value

- “improve data access between its main campus and its off-site data centre”
- “The distributed file system will allow the working set of data that is currently being accessed by researchers to be cached on campus using IBM’s GPFS product (also known Spectrum Scale) without any additional user involvement.”
- “If you want to touch some data remotely in the cloud at Polaris, you can access that data using this distributed file system. If you want to access that data in campus, it appears automatically and gets moved without the user’s involvement. So that lessens the burden,”
- “A major additional benefit for users working with data stored at Polaris is that bandwidth bottlenecks between the campus and Polaris are less likely to cause a slowdown in their work.”

## Customer feedback

- “GPFS is a parallel system, so it works well on high-performance computers, but it’s also a distributed file system. And they’re pretty smart guys [at IBM] that have worked out a lot of things over the years. It’s an old product, but it’s been constantly updated.”

Source: <http://www.itnews.com.au/news/qld-uni-debuts-its-own-data-storage-fabric-417506>

# Contrasting NAS Consolidation Opportunities

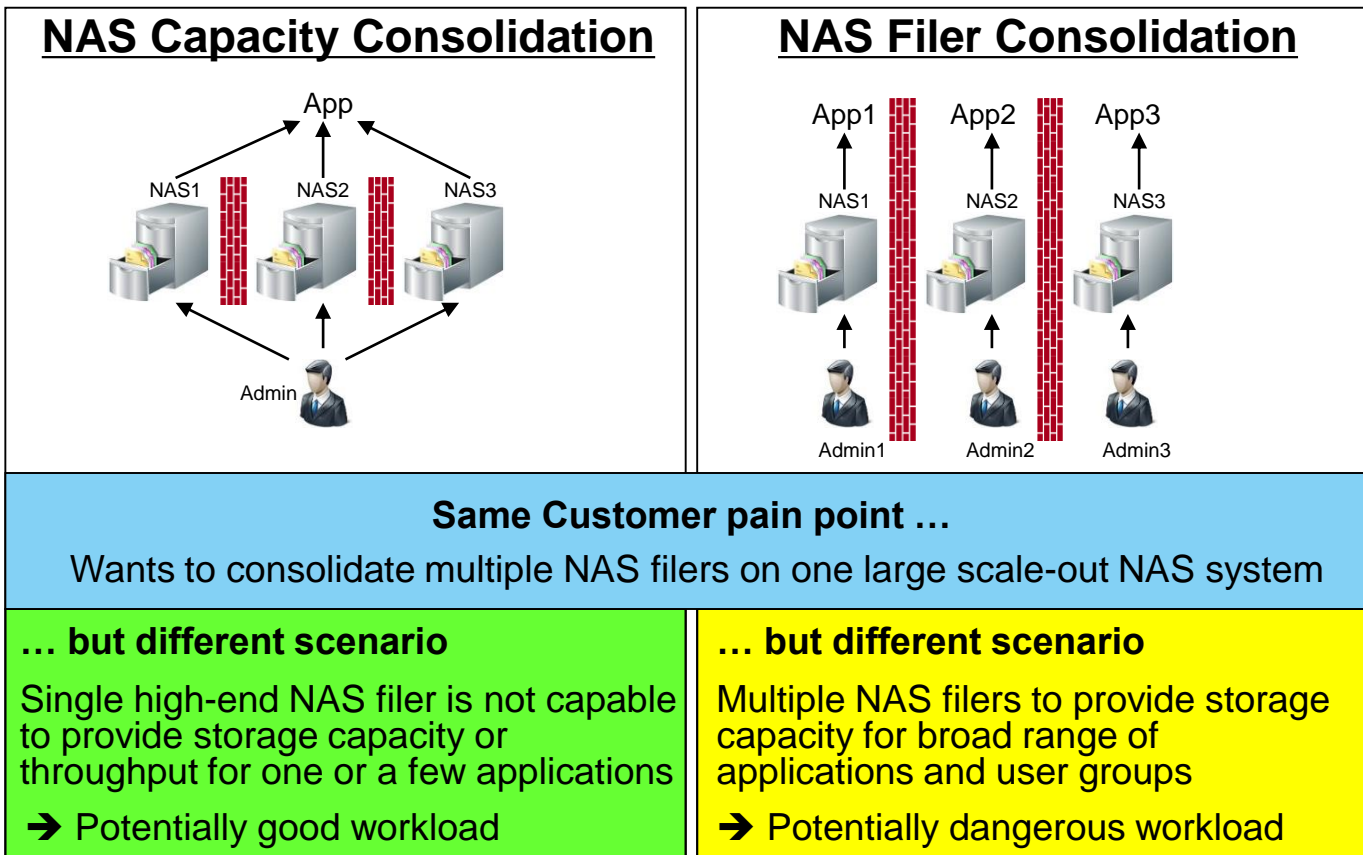

# Examples – Application Acceleration

**Core  
HPC**

**File-based  
Workflows**

**Application  
Acceleration**

**Virtual  
Infrastructure**

## **IBM Spectrum Scale**

**File Services / File Storage Virtualization / Application Integration**

**Network**

**Software-defined Storage Freedom**

## **Freedom of Choice**

**Choose Storage which Meets your Needs  
Flash // Disk // Tape // Object // Cloud**

# Application Acceleration

- The mature, fast and flexible file system accelerates a broad range of applications.
- Same applications have been covered in earlier user group meetings:
  - SAP HANA on IBM Elastic Storage Server (ESS)  
[http://files.gpfsug.org/presentations/2017/Ehningen/04 - SSUG17DE - Volker Fischer - SAP\\_HANA@Bosch, An Infrastructure Story.pdf](http://files.gpfsug.org/presentations/2017/Ehningen/04 - SSUG17DE - Volker Fischer - SAP_HANA@Bosch, An Infrastructure Story.pdf)
  - SAS on Spectrum Scale  
<http://files.gpfsug.org/presentations/2017/Ehningen/06 - SSUG17DE - Adrian Immler, Marco Pighetti - Performance Optimization for Risk Management.pdf>
  - Spectrum Protect on Spectrum Scale  
<http://files.gpfsug.org/presentations/2017/Ehningen/11 - SSUG17DE - Andre Gaschler, Stefan Schaedeli - Flexible Storage for Spectrum Protect.pdf>
- Which applications do you run on Spectrum Scale?
  - ➔ Whiteboard

## Examples – Virtual Infrastructure

**Core  
HPC**

**File-based  
Workflows**

**Application  
Acceleration**

**Virtual  
Infrastructure**

### **IBM Spectrum Scale**

**File Services / File Storage Virtualization / Application Integration**

**Network**

**Software-defined Storage Freedom**

### **Freedom of Choice**

**Choose Storage which Meets your Needs  
Flash // Disk // Tape // Object // Cloud**

# Spectrum Scale as Infrastructure Service for OpenStack



## IBM Spectrum Scale in an OpenStack Environment

Bill Owen  
Dean Hildebrand  
Sandeep Ramesh  
Gautam Shah  
Gaurang Tapase  
Kumar Nachiketa  
Kedar Karmarkar  
Larry Coyne

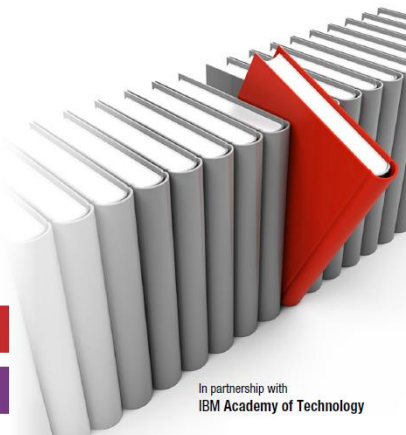

In partnership with  
IBM Academy of Technology

Cloud

Storage

IBM

Redpaper

# BEAR

## BIRMINGHAM ENVIRONMENT FOR ACADEMIC RESEARCH

### Introducing #BEARcloud ... our private cloud for research

Published on October 22, 2016



Simon Thompson  
Research Computing Infrastructure Architect at University of ...



<https://www.linkedin.com/pulse/introducing-bearcloud-our-private-cloud-research-simon-thompson>

# Spectrum Scale and Docker

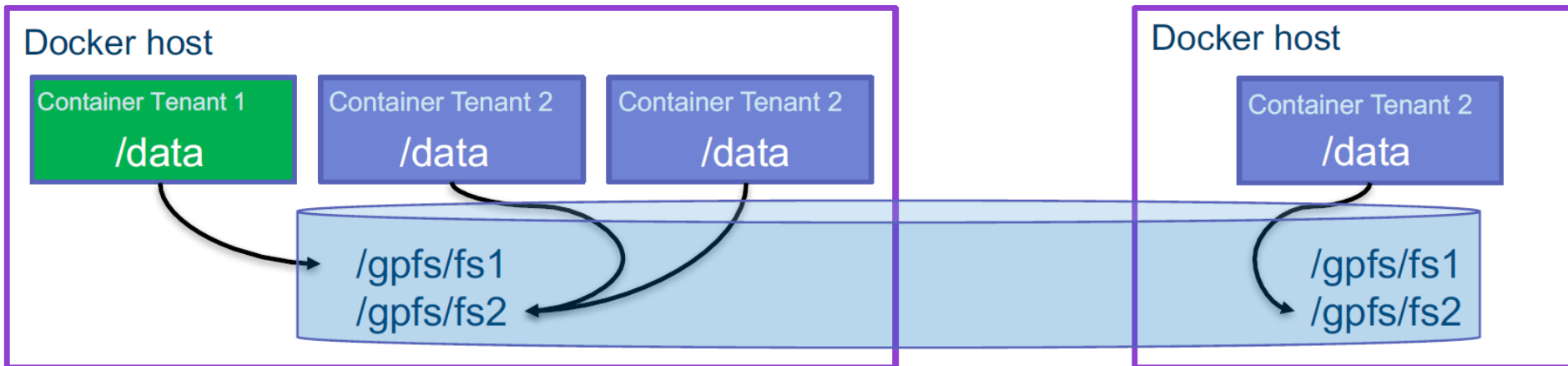

## Details

- ❑ Single or separate userid namespaces between containers and hosts
- ❑ Data sharing across containers and hosts
- ❑ All POSIX commands supported from container

## A Few Benefits

- ❑ Multi-tenant access
  - Container can only access its volumes
  - Allow root access in container without allowing root access to file system
  - ACLs can add an extra level of security
- ❑ Native client performance

# Spectrum Scale Container Volume Service Architecture

## Provisioning persistent storage for Docker and Kubernetes

- **Storage volume drivers** abstract storage complexities while exposing key capabilities
- Docker and Kubernetes have different mechanisms for provisioning storage
- Build a single service to provision volumes for that can be shared across all frameworks
- Support a variety of features, existing or new volumes, Quota, etc
- Currently working with Spectrum Computing
- Plan is to open-source

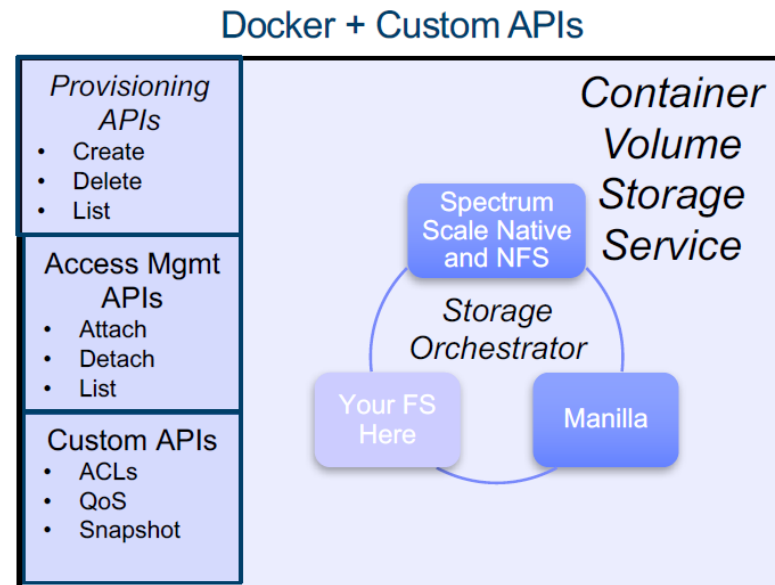



## Miscellaneous

**HPC**

**File-based  
Workflows**

**Application  
Acceleration**

**Virtual  
Infrastructure**

# IBM Spectrum Scale

**File Services / File Storage Virtualization / Application Integration**

**Network**

**Software-defined Storage Freedom**

## Freedom of Choice

**Choose Storage which Meets your Needs  
Flash // Disk // Tape // Object // Cloud**

# Selected new features and functions

- Problem Determination Enhancements (Talk by Mathias Dietz)
- Diagnosing network problems in IBM Spectrum Scale with mmnetverify (Blog)  
<https://developer.ibm.com/storage/2017/02/24/diagnosing-network-problems-ibm-spectrum-scale-mmnetverify/>
- Extension of the problem determination capabilities in IBM Spectrum Scale 4.2.2 (Blog)  
<https://developer.ibm.com/storage/2017/01/10/extension-of-the-problem-determination-capabilities-in-ibm-spectrum-scale-4-2-2/>
- Hortonworks as a Strategic Partner (Breakout session)  
<https://hortonworks.com/press-releases/ibm-delivers-new-platform-help-clients-address-storage-challenges-massive-scale/>
- REST API (Talk by Ulf Troppens)
- GUI Enhancements
- IBM Spectrum Scale Security (RedPaper)  
<https://www.redbooks.ibm.com/Redbooks.nsf/RedbookAbstracts/redp5426.html?Open>
- HPC enhancements for CORAL  
[http://files.gpfsug.org/presentations/2016/SC16/11\\_Sarp\\_Oral\\_Gautam\\_Shah\\_Spectrum\\_Scale\\_Enhancements\\_for\\_CORAL\\_v2.pdf](http://files.gpfsug.org/presentations/2016/SC16/11_Sarp_Oral_Gautam_Shah_Spectrum_Scale_Enhancements_for_CORAL_v2.pdf)
- What is new in Spectrum Scale 4.2.2 (Presentation)  
[http://files.gpfsug.org/presentations/2016/SC16/04\\_Scott\\_Fadden\\_Spectrum\\_Scale\\_Update.pdf](http://files.gpfsug.org/presentations/2016/SC16/04_Scott_Fadden_Spectrum_Scale_Update.pdf)

# Agenda – Berkeley – Apr 4<sup>th</sup>, 2017 – Building 50

09:00 - 10:00 Registration and Coffee

10:00 - 10:30 Welcome (Doris Conti, Bob Oesterlin, Kristy Kallback-Rose)

10:30 - 11:30 Spectrum Scale & ESS Update (Scott Fadden / Ulf Troppens)

11:30 - 12:30 Problem Avoidance - Best Practices in the Field (Brian Yaeger)

12:30 - 13:30 Lunch and Networking

13:30 - 15:30 Problem Determination - Deep Dive (Yuri Volobuev)

15:30 - 16:00 Coffee and Networking

16:00 - 17:00 Problem Determination - What's New? (Matthias Dietz)

17:00 - 18:00 Bring your favorite problem or performance issue. We will fix it now! (All)

# Agenda – Berkeley – Apr 5<sup>th</sup>, 2017 – Building 59

08:30 - 09:00 Coffee and Networking

- 09:00 - 10:00
- 1) Spectrum Scale Cloud Deployments (Solutions) (Christopher Maestas)
  - 2) Hadoop Integration and Support for HortonWorks HDP (Solutions) (Ted Hoover)
  - 3) Data Movement BoF: Staging data between GPFS and the Burst Buffer (David Paul);  
GPFS-HPSS Integration (Damian Hazen); open discussion of Data Movement Issues and Solutions

- 10:00 - 11:00
- 1) AFM - Introduction and Use Cases (Meet the Devs) (Scott Fadden)
  - 2) Life Sciences and Next Generation Sequencing with Spectrum Scale (Solutions) (Madhav Ponamgi)
  - 3) Cloud and Virtualization Discussion (BOF) (John Lewars)

- 11:00 - 12:00
- 1) Transparent Cloud Tiering - Introduction and Use Cases (Meet the Devs) (Rob Basham)
  - 2) Spectrum Protect on Spectrum Scale (Solutions) (Jason Basler)
  - 3) *<Open BoF based upon attendee interest> TBD*

12:00 - 13:00 Lunch and Networking

13:00 - 13:20 Catching rogue jobs before they overload the storage (Rosemary Francis (Ellexus))

13:20 - 13:40 A unified framework for scientific data management (Lisa Gerhardt) (NERSC)

13:40 - 14:00 Spectrum Scale in analytic ecosystems. With AFM (James McKenna) (DDN)

14:00 - 14:20 REST API (Ulf Troppens)

14:20 - 14:50 Coffee and Networking

14:50 - 15:20 Application Integration with Containers (Dean Hildebrand)

15:20 - 15:50 Challenges in Tracing (Vasily Tarasov)

15:50 - 16:00 Wrap-up (Doris Conti, Bob Oesterlin, Kristy Kallback-Rose)

# Agenda – Poll Break-out Sessions

## 09:00 - 10:00

- 1) Spectrum Scale Cloud Deployments (Solutions) (Christopher Maestas)
- 2) Hadoop Integration and Support for HortonWorks HDP (Solutions) (Ted Hoover)
- 3) Data Movement BoF: Staging data between GPFS and the Burst Buffer (David Paul);  
GPFS-HPSS Integration (Damian Hazen);  
Open discussion of Data Movement Issues and Solutions

## 10:00 - 11:00

- 1) AFM - Introduction and Use Cases (Meet the Devs) (Scott Fadden)
- 2) Life Sciences and Next Generation Sequencing with Spectrum Scale (Solutions) (Madhav Ponamgi)
- 3) Cloud and Virtualization Discussion (BOF) (John Lewars)

## 11:00 - 12:00

- 1) Transparent Cloud Tiering - Introduction and Use Cases (Meet the Devs) (Rob Basham)
- 2) Spectrum Protect on Spectrum Scale (Solutions) (Jason Basler)
- 3) *<Open BoF based upon attendee interest> TBD*

# Spectrum Scale User Group



The Spectrum Scale User Group is free to join and open to all using, interested in or integrating Spectrum Scale.

Independent of IBM. IBM supports with speaker.

Join the User Group activities to meet your peers and get access to experts from partners and IBM.



<http://www.spectrumscale.org/uk-may-2016-group-report/>

## Major meetings 2017:

- |                                |                |                    |
|--------------------------------|----------------|--------------------|
| - German User Meeting          | Mar 8+9,2017   | Ehningen, Germany  |
| - US User Group Meeting        | Apr 4+5,2017   | Berkeley, USA      |
| - Australia User Group Meeting | Apr 27, 2017   | Sydney, Australia  |
| - UK User Group Meeting        | May 9+10, 2017 | Manchester, UK     |
| - User Group Meeting @ ISC17   | Jun 19, 2017   | Frankfurt, Germany |
| - User Group Meeting @ SC17    | Nov 12, 2017   | Orlando, USA       |

Web page: <http://www.spectrumscale.org/>

Presentations: <http://www.spectrumscale.org/presentations/>

Mailing list: <http://www.spectrumscale.org/join/>

Contact: <http://www.spectrumscale.org/committee/>

# Engagement Process

- 1 Core HPC
- 1 File-based Workflows
- 1 Application Acceleration
- 1 Virtual Infrastructure

1) Understand Use Case

2 **IBM Spectrum Scale**  
File Services / Filesystem Virtualization / Application Integration  
4 Network  
Software-defined Storage Freedom

2) Define Spectrum Scale Configuration

3 **Freedom of Choice**  
Choose Storage which Meets your Needs  
Flash // Disk // Tape // Object // Cloud

3) Select Best of Breed Storage

4) Define Network Configuration

## Keep in mind



- Spectrum Scale inherits all the benefits and maturity of GPFS and continues to support the needs of GPFS customers, in particular for HPC.
- Spectrum Scale is a file virtualization layer, which accelerates file- and object-based workflows, and reduces the costs for owning and accessing data on file.
- Spectrum Scale accelerates selected applications and simplifies the management of their underlying storage.
- Spectrum Scale is adding support for virtualized frameworks such as OpenStack, Docker and Kubernetes
- Get involved in Spectrum Scale User Group activities (e.g. speaker at the next User Group Meeting)!
- Volunteer as reference!
- Enjoy this User Group Meeting and make it an active exchange of thoughts and experience!



Copyright © 2016 by International Business Machines Corporation. All rights reserved.

No part of this document may be reproduced or transmitted in any form without written permission from IBM Corporation.

Product data has been reviewed for accuracy as of the date of initial publication. Product data is subject to change without notice. This document could include technical inaccuracies or typographical errors. IBM may make improvements and/or changes in the product(s) and/or program(s) described herein at any time without notice. Any statements regarding IBM's future direction and intent are subject to change or withdrawal without notice, and represent goals and objectives only. References in this document to IBM products, programs, or services does not imply that IBM intends to make such products, programs or services available in all countries in which IBM operates or does business. Any reference to an IBM Program Product in this document is not intended to state or imply that only that program product may be used. Any functionally equivalent program, that does not infringe IBM's intellectually property rights, may be used instead.

THE INFORMATION PROVIDED IN THIS DOCUMENT IS DISTRIBUTED "AS IS" WITHOUT ANY WARRANTY, EITHER OR IMPLIED. IBM LY DISCLAIMS ANY WARRANTIES OF MERCHANTABILITY, FITNESS FOR A PARTICULAR PURPOSE OR NONINFRINGEMENT. IBM shall have no responsibility to update this information. IBM products are warranted, if at all, according to the terms and conditions of the agreements (e.g., IBM Customer Agreement, Statement of Limited Warranty, International Program License Agreement, etc.) under which they are provided. Information concerning non-IBM products was obtained from the suppliers of those products, their published announcements or other publicly available sources. IBM has not tested those products in connection with this publication and cannot confirm the accuracy of performance, compatibility or any other claims related to non-IBM products. IBM makes no representations or warranties, ed or implied, regarding non-IBM products and services.

The provision of the information contained herein is not intended to, and does not, grant any right or license under any IBM patents or copyrights. Inquiries regarding patent or copyright licenses should be made, in writing, to:

IBM Director of Licensing  
IBM Corporation  
North Castle Drive  
Armonk, NY 1 0504- 785  
U.S.A.

# Information and trademarks



IBM, the IBM logo, ibm.com, IBM System Storage, IBM Spectrum Storage, IBM Spectrum Control, IBM Spectrum Protect, IBM Spectrum Archive, IBM Spectrum Virtualize, IBM Spectrum Scale, IBM Spectrum Accelerate, Softlayer, and XIV are trademarks of International Business Machines Corp., registered in many jurisdictions worldwide. A current list of IBM trademarks is available on the Web at "Copyright and trademark information" at <http://www.ibm.com/legal/copytrade.shtml>

The following are trademarks or registered trademarks of other companies.

Adobe, the Adobe logo, PostScript, and the PostScript logo are either registered trademarks or trademarks of Adobe Systems Incorporated in the United States, and/or other countries.

IT Infrastructure Library is a Registered Trade Mark of AXELOS Limited.

Linear Tape-Open, LTO, the LTO Logo, Ultrium, and the Ultrium logo are trademarks of HP, IBM Corp. and Quantum in the U.S. and other countries.

Intel, Intel logo, Intel Inside, Intel Inside logo, Intel Centrino, Intel Centrino logo, Celeron, Intel Xeon, Intel SpeedStep, Itanium, and Pentium are trademarks or registered trademarks of Intel Corporation or its subsidiaries in the United States and other countries.

Linux is a registered trademark of Linus Torvalds in the United States, other countries, or both.

Microsoft, Windows, Windows NT, and the Windows logo are trademarks of Microsoft Corporation in the United States, other countries, or both.

Java and all Java-based trademarks and logos are trademarks or registered trademarks of Oracle and/or its affiliates.

Cell Broadband Engine is a trademark of Sony Computer Entertainment, Inc. in the United States, other countries, or both and is used under license therefrom.

ITIL is a Registered Trade Mark of AXELOS Limited.

UNIX is a registered trademark of The Open Group in the United States and other countries.

\* All other products may be trademarks or registered trademarks of their respective companies.

## Notes:

Performance is in Internal Throughput Rate (ITR) ratio based on measurements and projections using standard IBM benchmarks in a controlled environment. The actual throughput that any user will experience will vary depending upon considerations such as the amount of multiprogramming in the user's job stream, the I/O configuration, the storage configuration, and the workload processed. Therefore, no assurance can be given that an individual user will achieve throughput improvements equivalent to the performance ratios stated here.

All customer examples cited or described in this presentation are presented as illustrations of the manner in which some customers have used IBM products and the results they may have achieved. Actual environmental costs and performance characteristics will vary depending on individual customer configurations and conditions.

This publication was produced in the United States. IBM may not offer the products, services or features discussed in this document in other countries, and the information may be subject to change without notice. Consult your local IBM business contact for information on the product or services available in your area.

All statements regarding IBM's future direction and intent are subject to change or withdrawal without notice, and represent goals and objectives only.

Information about non-IBM products is obtained from the manufacturers of those products or their published announcements. IBM has not tested those products and cannot confirm the performance, compatibility, or any other claims related to non-IBM products. Questions on the capabilities of non-IBM products should be addressed to the suppliers of those products.

Prices subject to change without notice. Contact your IBM representative or Business Partner for the most current pricing in your geography.

This presentation and the claims outlined in it were reviewed for compliance with US law. Adaptations of these claims for use in other geographies must be reviewed by the local country counsel for compliance with local laws.

# Special notices



This document was developed for IBM offerings in the United States as of the date of publication. IBM may not make these offerings available in other countries, and the information is subject to change without notice. Consult your local IBM business contact for information on the IBM offerings available in your area.

Information in this document concerning non-IBM products was obtained from the suppliers of these products or other public sources. Questions on the capabilities of non-IBM products should be addressed to the suppliers of those products.

IBM may have patents or pending patent applications covering subject matter in this document. The furnishing of this document does not give you any license to these patents. Send license inquires, in writing, to IBM Director of Licensing, IBM Corporation, New Castle Drive, Armonk, NY 10504-1785 USA.

All statements regarding IBM future direction and intent are subject to change or withdrawal without notice, and represent goals and objectives only.

The information contained in this document has not been submitted to any formal IBM test and is provided "AS IS" with no warranties or guarantees either expressed or implied.

All examples cited or described in this document are presented as illustrations of the manner in which some IBM products can be used and the results that may be achieved. Actual environmental costs and performance characteristics will vary depending on individual client configurations and conditions.

IBM Global Financing offerings are provided through IBM Credit Corporation in the United States and other IBM subsidiaries and divisions worldwide to qualified commercial and government clients. Rates are based on a client's credit rating, financing terms, offering type, equipment type and options, and may vary by country. Other restrictions may apply. Rates and offerings are subject to change, extension or withdrawal without notice.

IBM is not responsible for printing errors in this document that result in pricing or information inaccuracies.

All prices shown are IBM's United States suggested list prices and are subject to change without notice; reseller prices may vary.

IBM hardware products are manufactured from new parts, or new and serviceable used parts. Regardless, our warranty terms apply.

Any performance data contained in this document was determined in a controlled environment. Actual results may vary significantly and are dependent on many factors including system hardware configuration and software design and configuration. Some measurements quoted in this document may have been made on development-level systems. There is no guarantee these measurements will be the same on generally-available systems. Some measurements quoted in this document may have been estimated through extrapolation. Users of this document should verify the applicable data for their specific environment.