



# HPC @ automotive supplier (part II)



# / AGENDA

01 / Zwei in eins – ein dual-Cluster System

02 / Das Herzstück – der Storage

# / FALSCH ZUGEORDNETE ZITATE

©„DIE KÄNGURU CHRONIKEN“ VON MARC-UWE KLING

„Ehrlich währt am längsten“

Uli Hoeneß

<Original: Redensart>



# / WAS MACHT EIN HPC CLUSTER BEI EINEM AUTOMOBIL ZULIEFERER? BEISPIELE

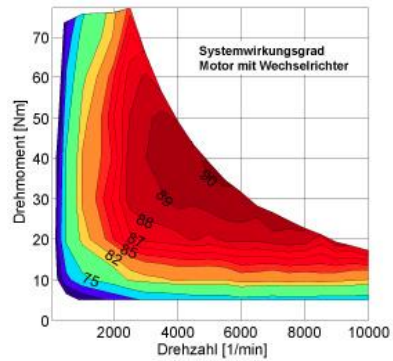
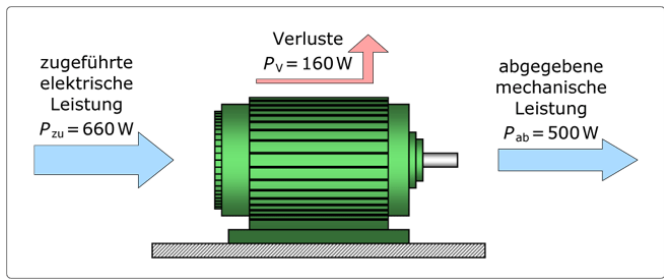
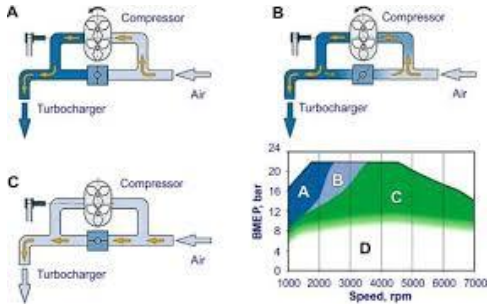
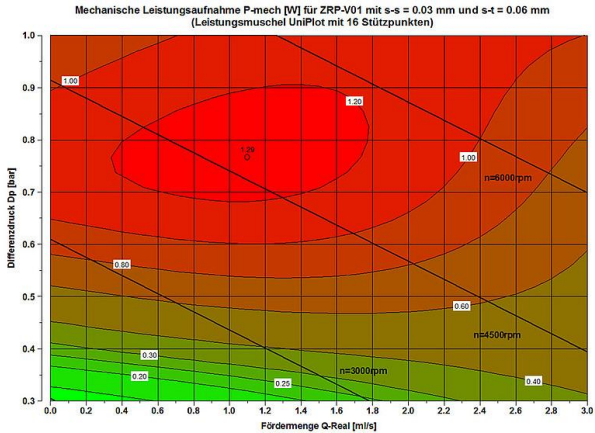
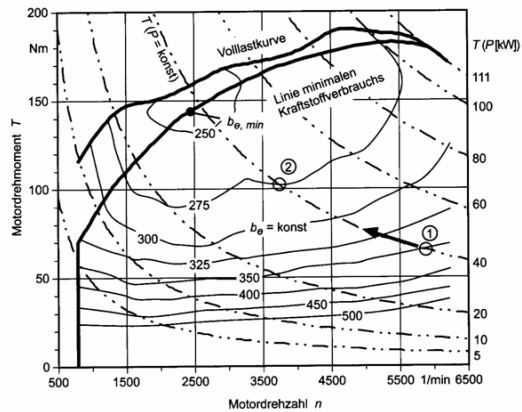
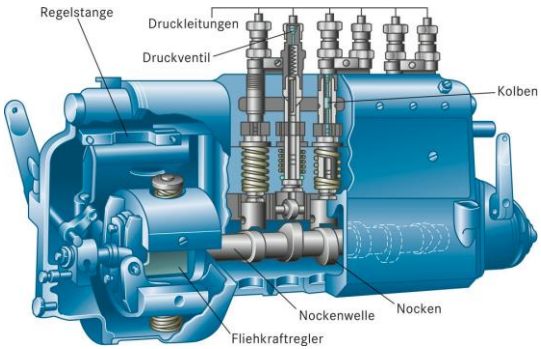

# / ZWEI IN EINS – EIN DUAL-CLUSTER SYSTEM

## ÜBERSICHT

- Generell gilt: Multi Vendor Strategie

- Compute Cluster A:            aktuell



- 412 Nodes
- 4.944 CPU Cores (Haswell)
- 30 TB RAM

- Compute Cluster B:            aktuell



- 304 Nodes
- 8.512 CPU Cores (Boadwell)
- 55 TB RAM

- Storage:                            aktuell



- 1,2 PB für scratch und home
- 600 TB für archive

# / ZWEI IN EINS – EIN DUAL-CLUSTER SYSTEM DIE IDEE

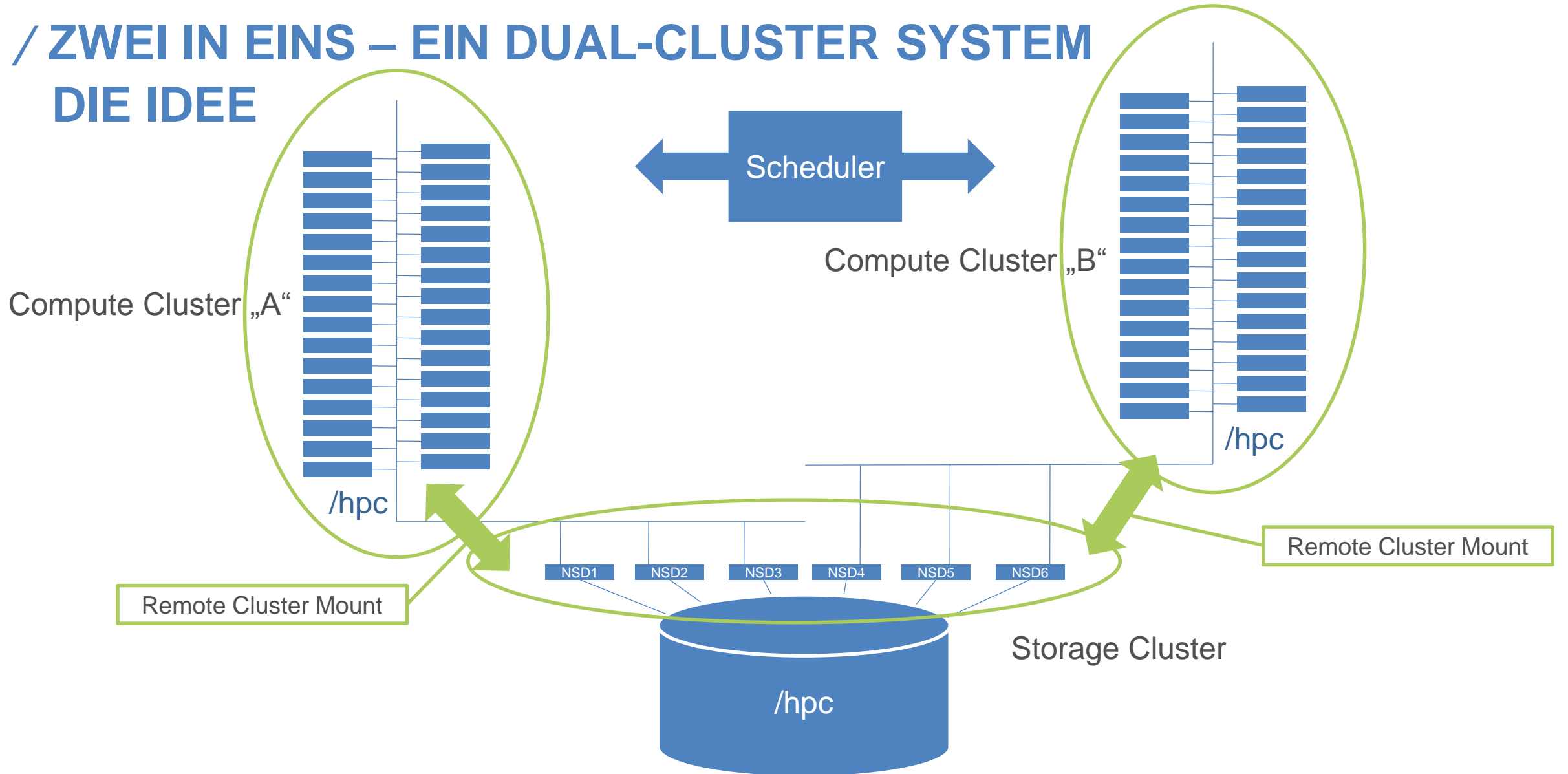

# / ZWEI IN EINS – EIN DUAL-CLUSTER SYSTEM DIE IDEE

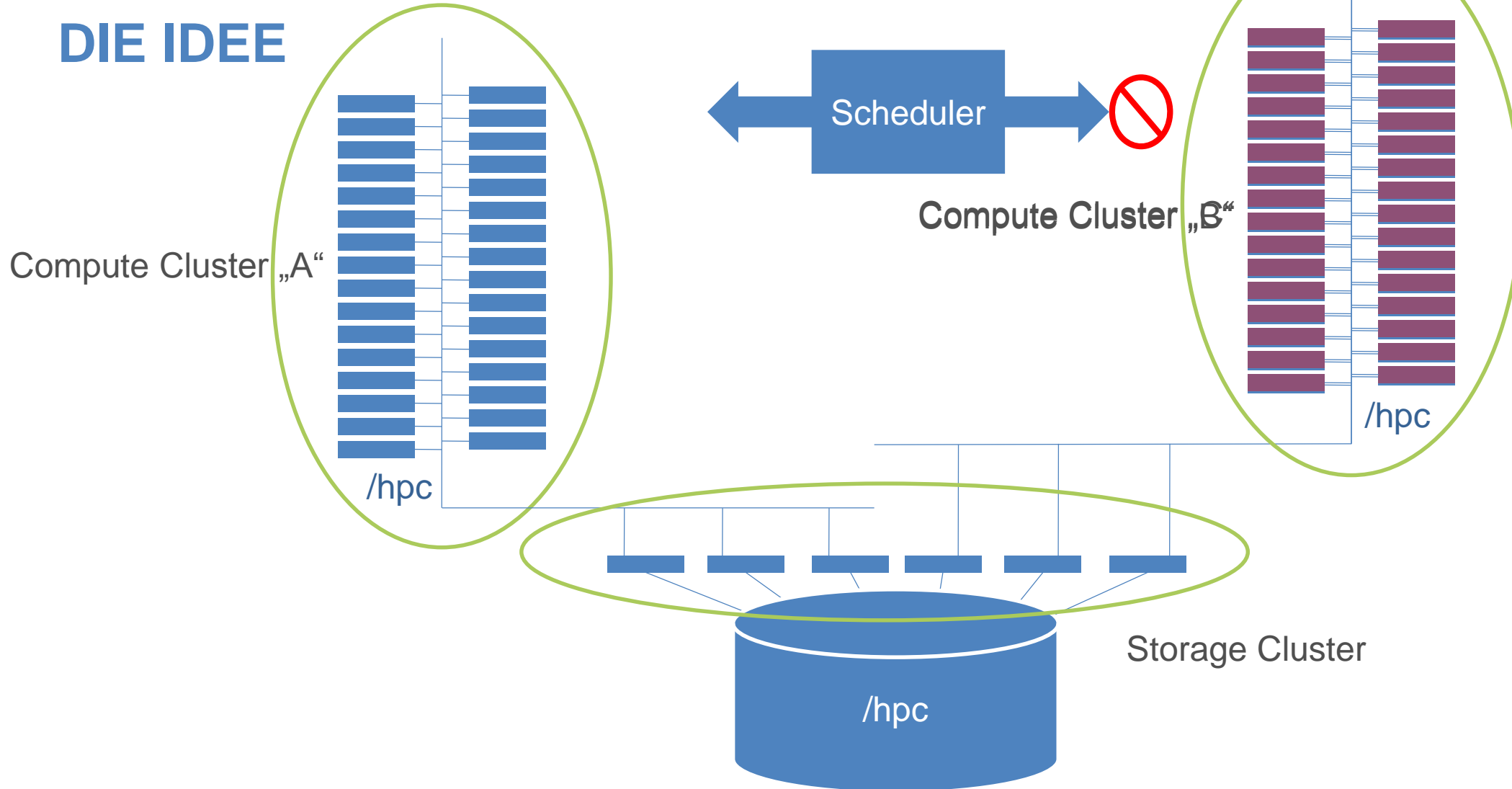

# / ZWEI IN EINS – EIN DUAL-CLUSTER SYSTEM DAS PROBLEM I

/fs1 NDS1=N1,N2

/fs2 NDS1=N2,N1

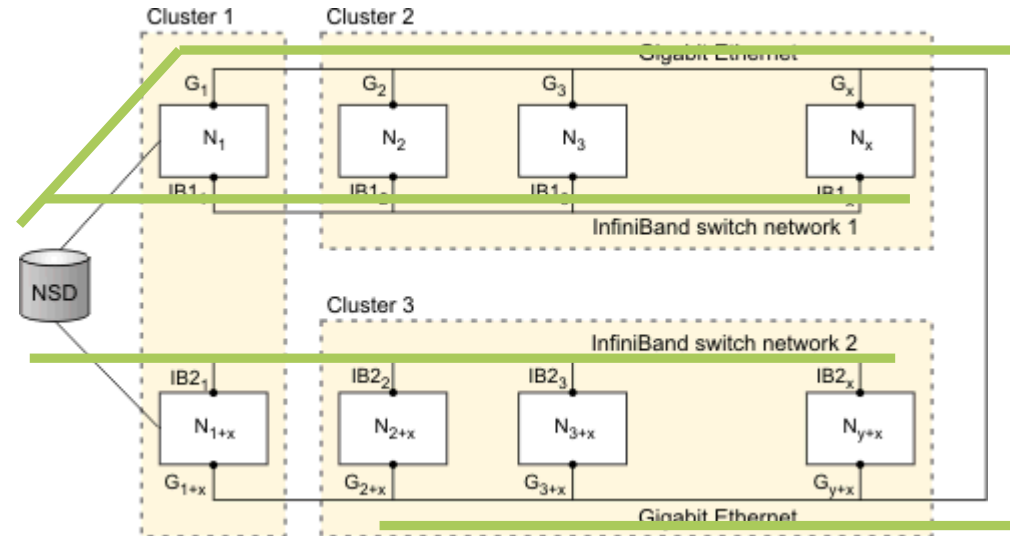



# / ZWEI IN EINS – EIN DUAL-CLUSTER SYSTEM

## DAS PROBLEM II

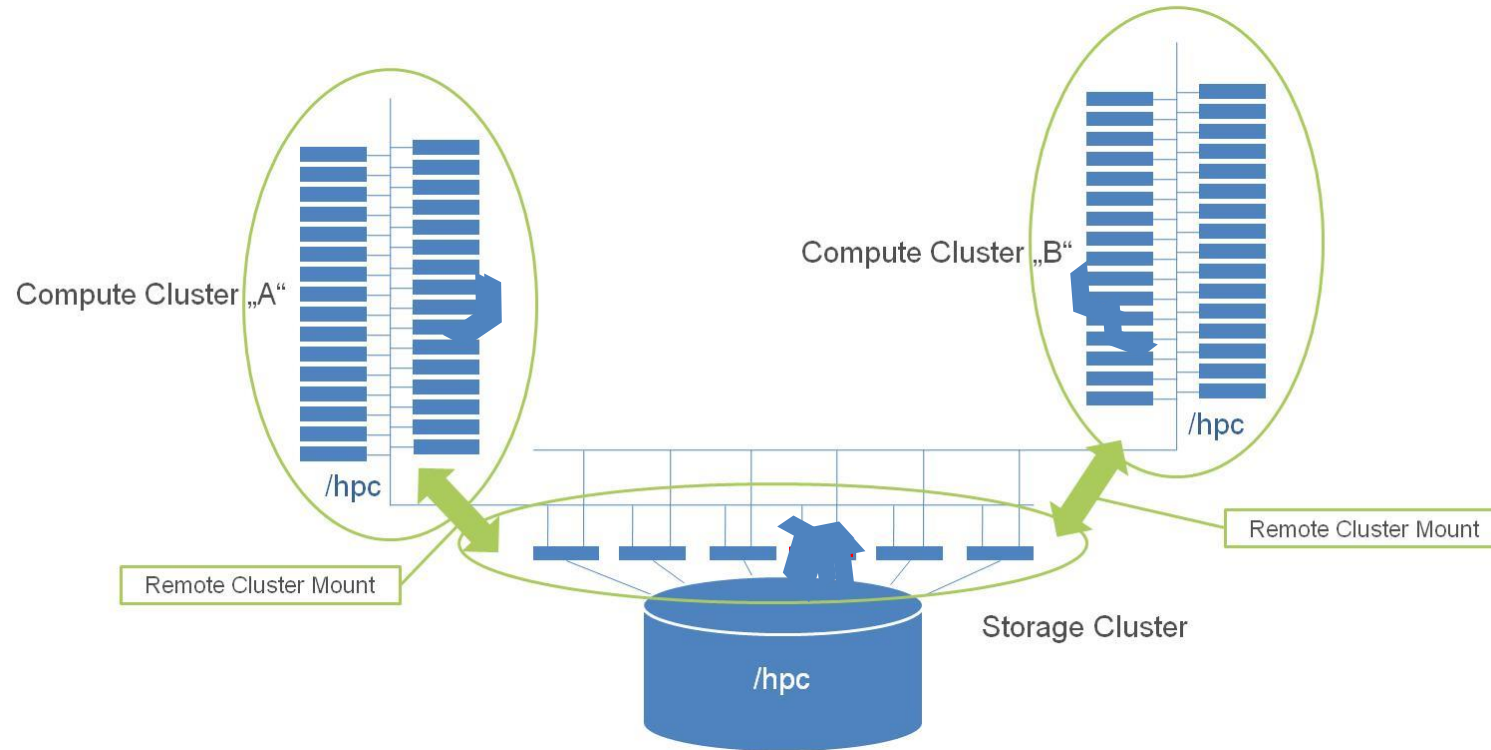

- Es gibt einen Cluster, der das File System bereitstellt, und zwei Remote Cluster, die auf diesem Filesystem arbeiten
- Greifen zwei und mehr Remote Cluster auf das gleiche Filesystem zu, erfolgt das Block Level Locking über den zentralen Cluster

# / ZWEI IN EINS – EIN DUAL-CLUSTER SYSTEM DIE LÖSUNG

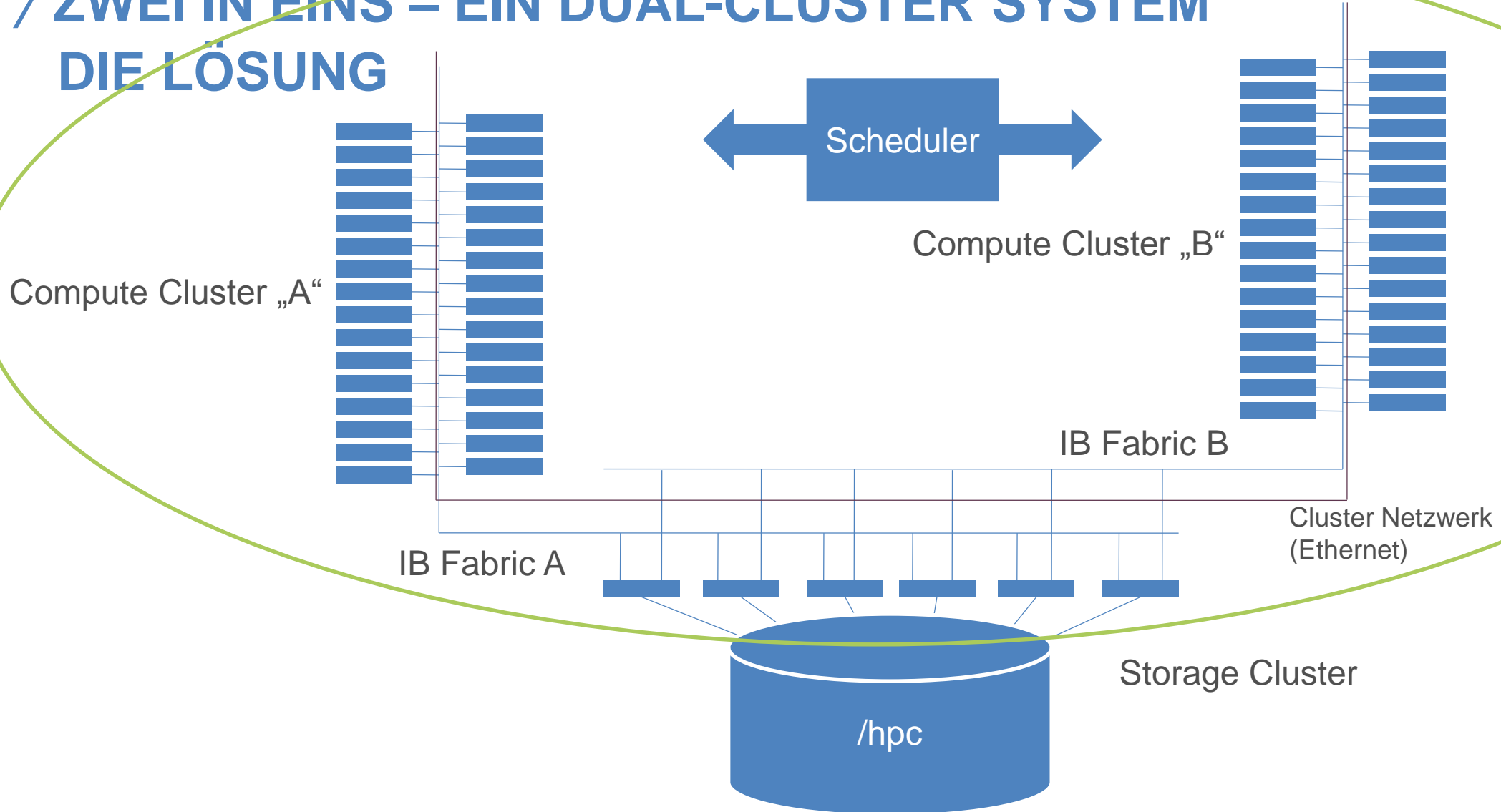

# / AGENDA

01 / Zwei in eins – ein dual-Cluster System

02 / Das Herzstück – der Storage

# / FALSCH ZUGEORDNETE ZITATE

©„DIE KÄNGURU CHRONIKEN“ VON MARC-UWE KLING

„So viel Geld lässt sich, weiß Gott, nicht mit etwas Gutem verdienen.“

Larry Ellison

<Original: Friedrich Schiller, Kabale und Liebe>



# / DAS HERZSTÜCK – DER STORAGE KONFIGURATION



GridScaler GS14KX

24 x 800 GB SSDs, RAID 1 (8,5TB netto, Metadaten)

840 x 2TB NL-SAS in 10 x 84er HD Expansion Drawer

Raid6 8D+2P

Enclosure loss protection (bis zu 2 Encl.)

1,2 PB Netto

12 x EDR IB zu den NSD Servern



# / DAS HERZSTÜCK – DER STORAGE AUFBAU

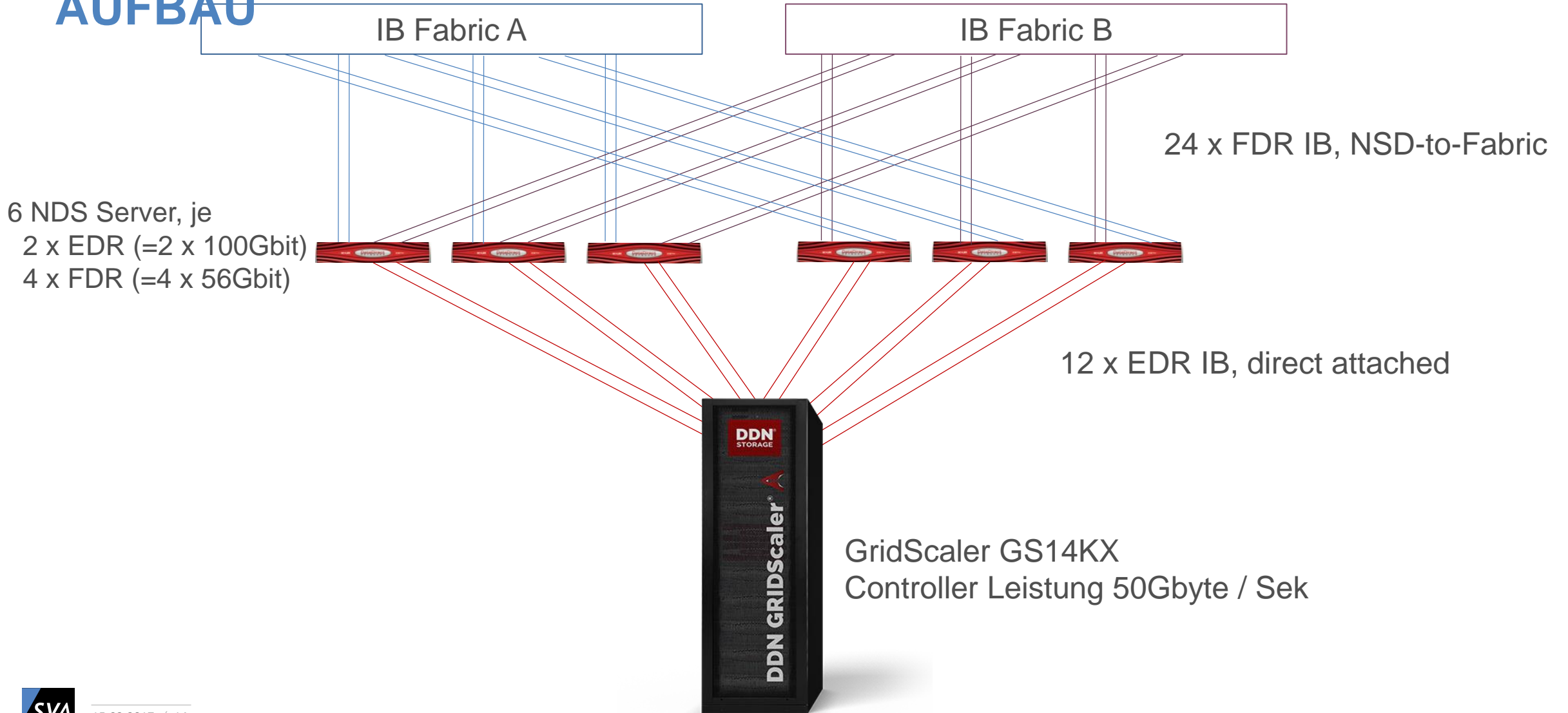

# / DAS HERZSTÜCK – DER STORAGE LEISTUNG

Leistungstest „sequentiell“ GPFS Filesystem auf GS14K:

FS-Blocksize = 8MB

16 HPC Nodes

2 x gpfsperf seq / node

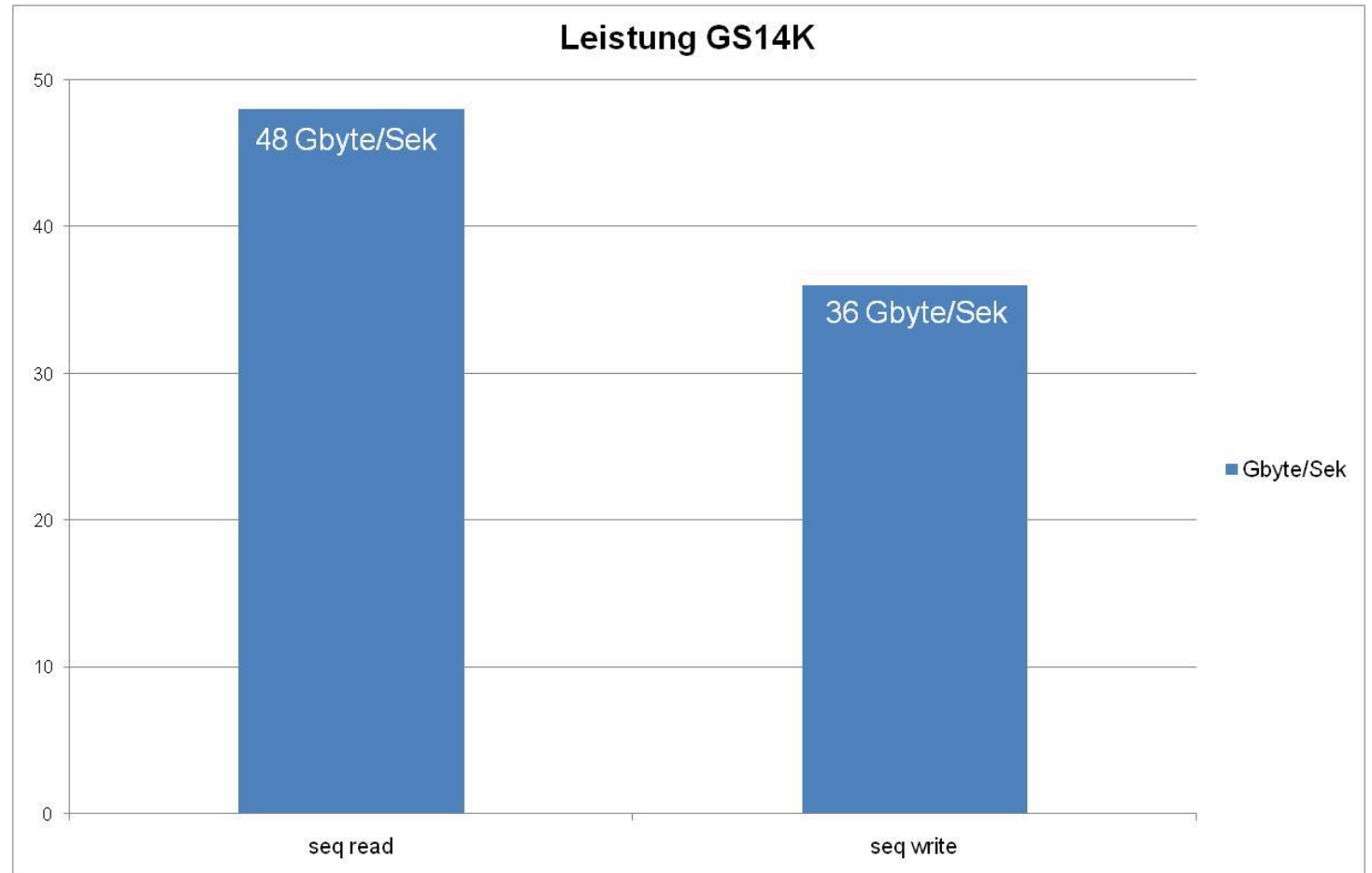

# / FALSCH ZUGEORDNETE ZITATE

©„DIE KÄNGURU CHRONIKEN“ VON MARC-UWE KLING

„Ist die Katze gesund, freut sich der Mensch.“

Erwin Schrödinger

<Original: Kitekat Werbung>







## JOCHEN ZELLER

System Architekt

---

Tel.: +49 151 180 256 77

Mail: [jochen.zeller@sva.de](mailto:jochen.zeller@sva.de)

# / BACKUP FOLIEN – WEITERE KENNZAHLEN GS14K

Metarates, ermittelt mit Spectrum Scale 4.1:

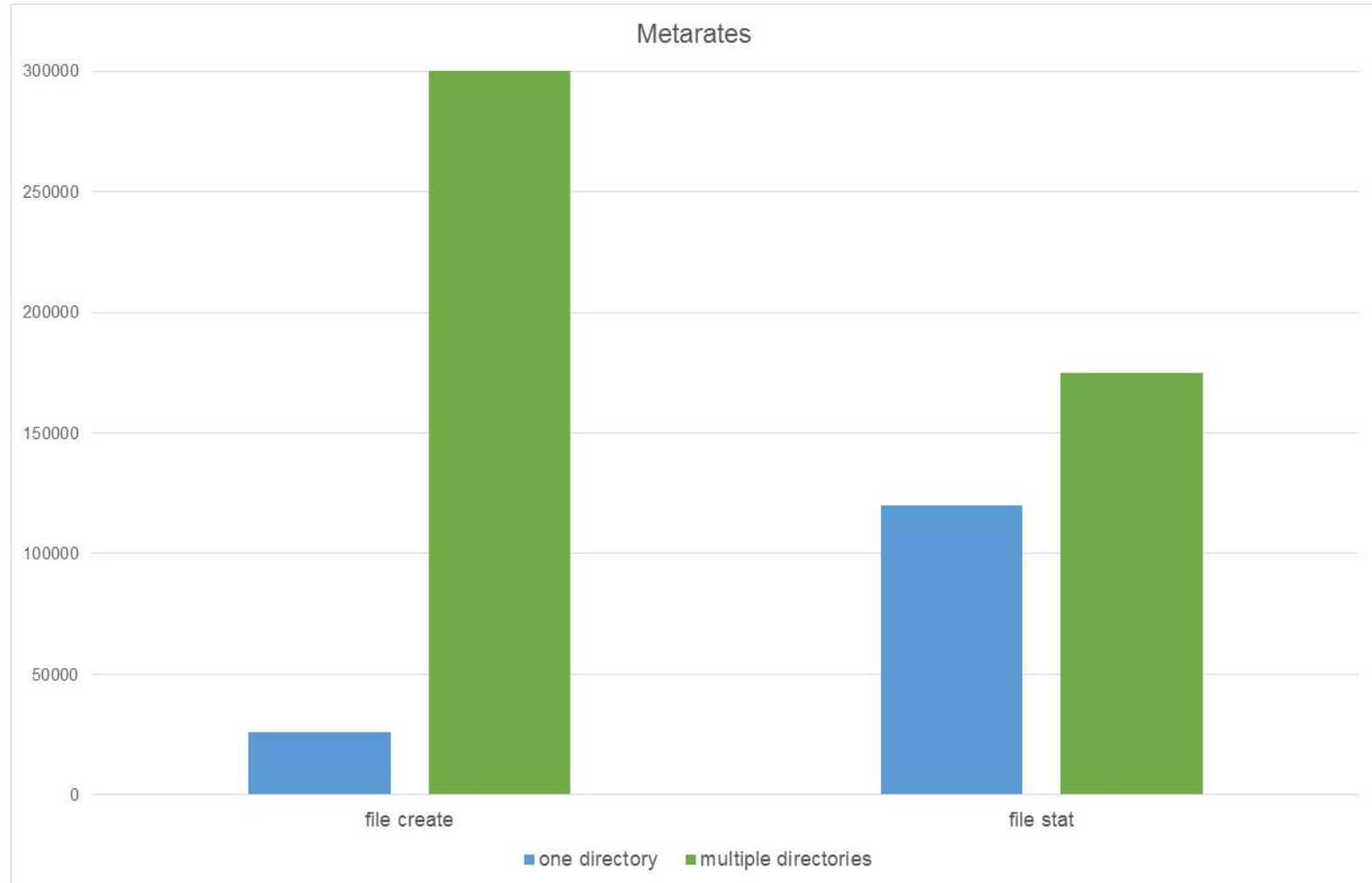

# / BACKUP FOLIEN – WEITERE KENNZAHLEN GS14K

random read & random write (ohne Cache hits):

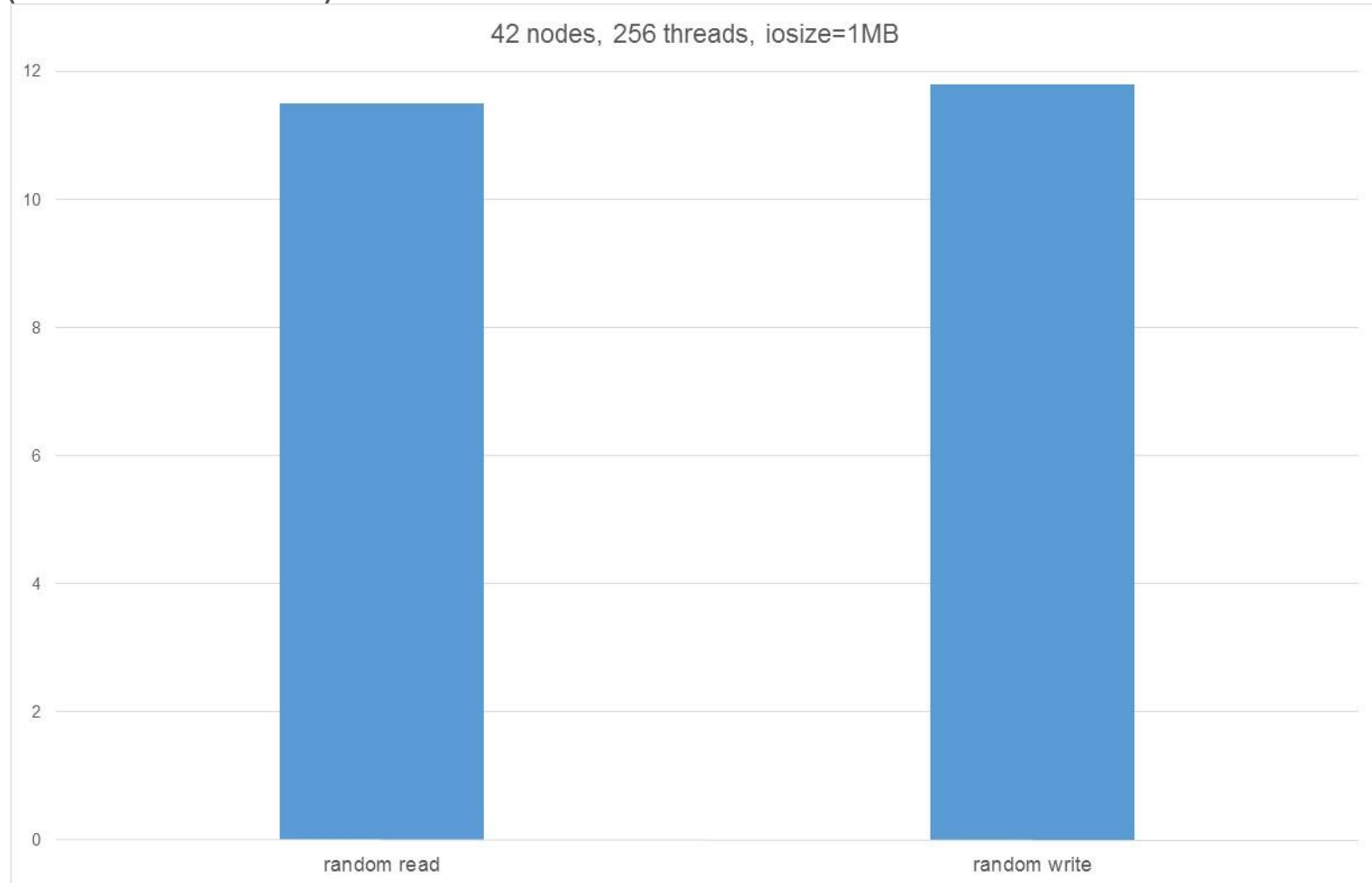

# ÜBER UNS / UNTERNEHMEN

16  
Standorte

Wiesbaden

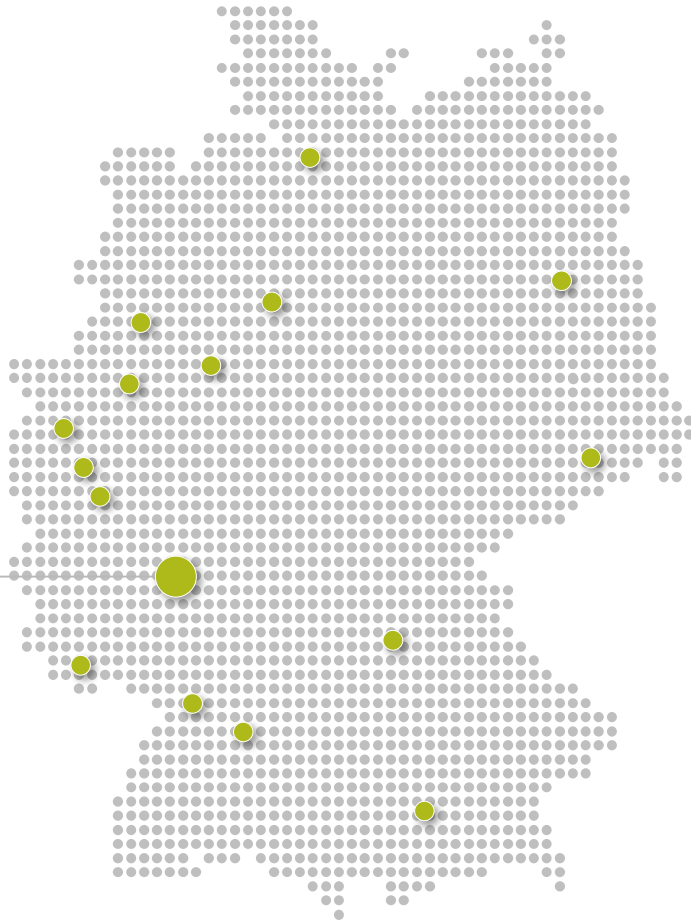

6 TOP  
Branchen



Automotive



Retail



Public



Maschinen &  
Anlagenbau



Finance &  
Insurance



Telekommunikation

# ÜBER UNS / UNTERNEHMEN

## Mitarbeiter

650

2017

590

2016

464

2015



## Umsatz in Mio €

245

2014

298

2015

403

2016

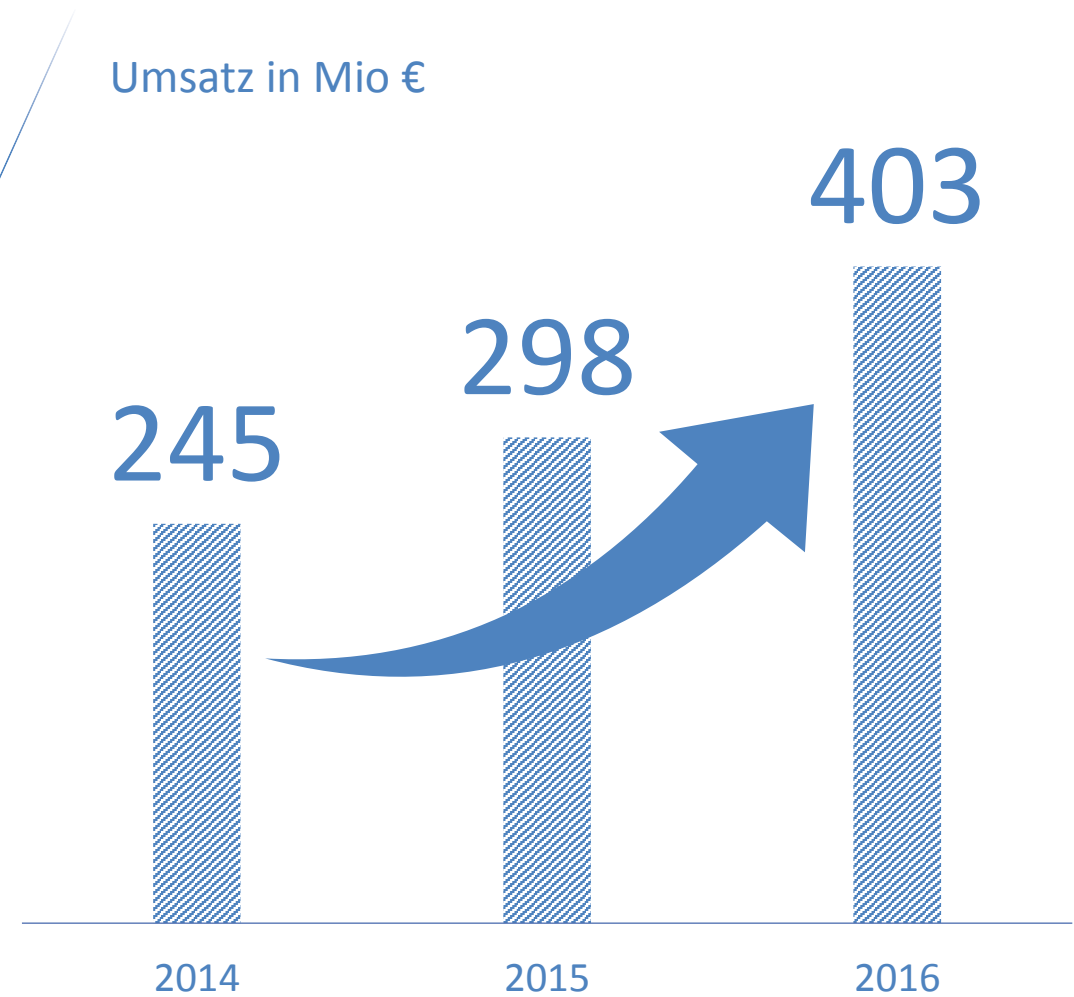

# ÜBER UNS / UNTERNEHMEN

# 1997

gegründet

# 1000+

Kunden



**PHILIPP ALEXANDER**

Diplom Ingenieur  
Vertrieb & Finanzen



**SVEN EICHELBAUM**

Diplom Betriebswirt  
Produkte & Services

# / WIR ÜBERNEHMEN VERANTWORTUNG



Mehr als **330 technische Experten** beraten & integrieren die individuell auf Sie zugeschnittene Lösung.

Produkt- bzw. herstellerübergreifende **Lösungsentwicklung**

Enge Bindung mit Zugang zu **Herstellerlaboren** und Einfluss auf Roadmap

Mehrere hundert Lösungen im **großen Demo-Labor**

Portfolio sorgfältig **für unsere Kunden ausgewählt**  
Über 30 Herstellerpartnerschaften

... ..  
...

# / WIR ÜBERNEHMEN VERANTWORTUNG



/ Für Implementierung und  
Dokumentation

**Professional Services**

/ Langfristiger Support,

**24 x 7 Operations Center**

/ Sicherstellung der Hersteller-  
supports durch regelmäßige

**Health Checks**

/ Zentraler und sicherer Zugang  
zum Kunden und

**SVA Customer Center**

/ 90 hochqualifizierte  
System Engineers für

**Operational Services**

/ ... ..

...



WAS MACHT UNS EINZIGARTIG?

# / SVA PARTNERSCHAFTEN



# WAS MACHT UNS EINZIGARTIG?

## / SVA ...



Platz 2 in der Umsatzklasse ab 250 Millionen €

- › Inhabergeführt
- › Hohe Mitarbeiterzufriedenheit und Loyalität
- › Langfristige technische Betreuung unserer gelieferten Lösungen
- › Überdurchschnittliche Kundenzufriedenheit und Weiterempfehlungsrate

\*Gültig und nutzbar von 17.01.2017 bis 16.01.2018, darf nicht verändert werden.